

**Specifications**

Nominal Voltage		12 V
Capacity (25°C)	20HR(10.5V)	250 Ah
	5HR(10.2V)	195Ah
	1HR(9.6V)	145Ah
Dimension	Length	521 ± 2mm (20.51inch)
	Width	269 ± 2mm (10.59inch)
	Height	220 ± 2mm (8.66inch)
	Total Height	220 ± 2mm (8.66inch)
Approx. Weight		75 kg (145.2lbs) ± 4%
Terminal type		T11
Internal resistance (Fully charged, 25°C)		Approx. 2.9m Ω
Capacity affected by temperature (10HR)	40°C	103%
	25°C	100%
	0°C	88%
	-15°C	70%
Self-discharge (25°C)	3 month	Remaining Capacity: 94%
	6 month	Remaining Capacity: 88%
	12 month	Remaining Capacity: 75%
Nominal operating temperature		25°C ± 3°C (77°F ± 5°F)
Operating temperature range	Discharge	-15°C ~ 50°C (5°F ~ 131°F)
	Charge	-10°C ~ 50°C (14°F ~ 131°F)
	Storage	-20°C ~ 50°C (-4°F ~ 131°F)
Float charging voltage(25°C)		13.50 to 13.80V Temperature compensation: -18mV/°C
Cyclic charging voltage(25°C)		14.10 to 14.40V Temperature compensation: -30mV/°C
Maximum charging current		50A
Terminal material		Copper
Maximum discharge current		2500A(5 sec.)
Designed floating life(20°C)		15 years

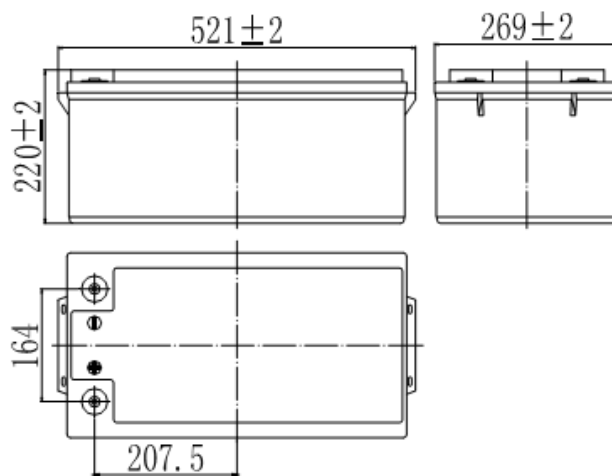

**Dimensions**



**Terminal**

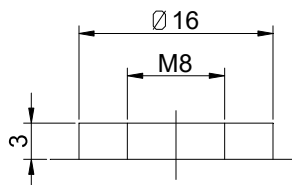

Terminal T11

- ◆ Gelled electrolyte technology;
- ◆ PVC separator;
- ◆ Recognized by UL & CE;
- ◆ ABS container.

**Constant Current Discharge Characteristics (A, 25°C)**

F.V/TIME	15min	30min	60min	2h	3h	4h	5h	6h	8h	10h	20h	48h	120h
9.60V	338	233	145	85.0	60.0	47.3	39.5	33.8	26.3	23.4	12.8	---	---
9.90V	330	229	144	84.5	59.5	47.0	39.3	33.5	26.0	23.4	12.8	---	---
10.2V	318	221	140	83.8	59.3	46.5	39.0	33.3	26.0	23.3	12.8	5.58	---
10.5V	308	216	138	82.5	58.8	46.3	38.8	33.0	25.8	23.1	12.5	5.54	2.30
10.8V	290	208	133	80.5	57.0	44.8	37.5	32.0	25.0	23.0	12.5	5.54	2.30

**Constant Power Discharge Characteristics (Watt, 25°C)**

F.V/TIME	15min	30min	60min	2h	3h	4h	5h	6h	8h	10h	20h	48h	120h
9.60V	3768	2655	1675	990	708	558	470	400	313	280	154	---	---
9.90V	3675	2603	1650	983	705	555	468	398	313	280	154	---	---
10.2V	3540	2523	1610	975	700	550	463	395	310	280	154	66.9	---
10.5V	3420	2463	1578	960	695	548	460	393	308	278	151	66.5	27.8
10.8V	3240	2373	1528	935	673	530	448	380	298	275	151	66.5	27.5

Note: The above characteristics data can be obtained within three charge/discharge cycles.

Discharge Characteristics(25°C)

Charging Characteristics(25°C)

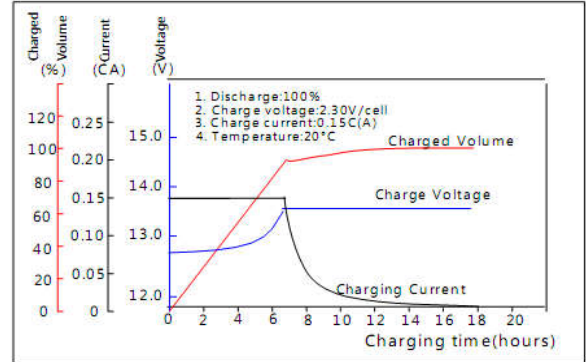
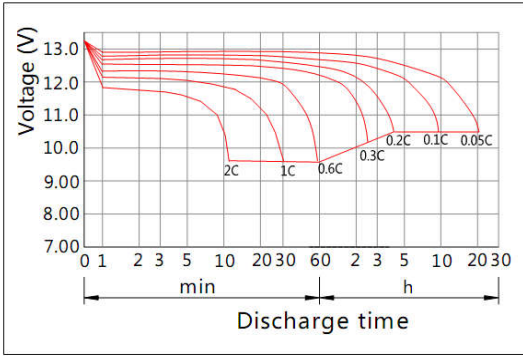

Effect of Temperature on Capacity

Self-discharge Characteristics

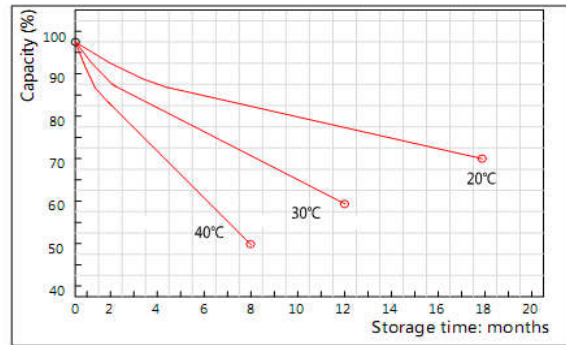
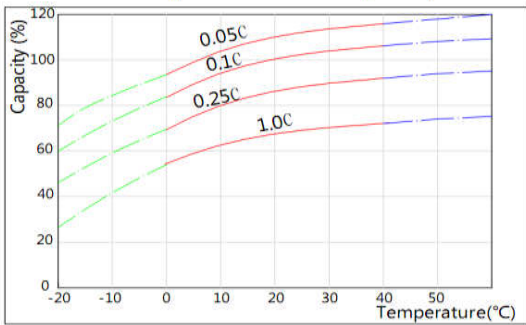

The Relationship for Open Circuit Voltage and Residual Capacity (25°C)

The Relationship for Charging Voltage and Temperature

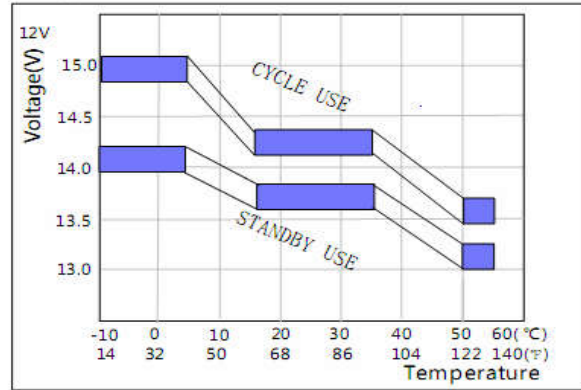
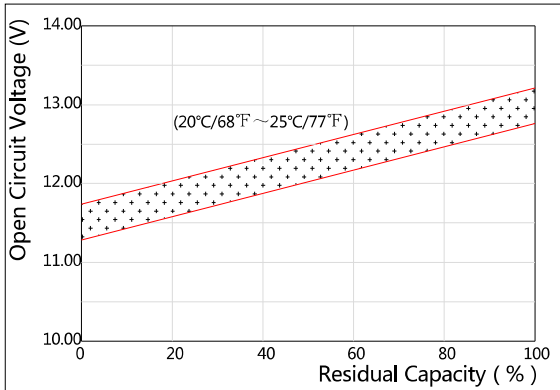

Floating Life on Temperature

Cycle Life on D.O.D(25°C)

