

Specifications

Nominal Voltage		12 V
Capacity (25°C)	20HR(10.5V)	150Ah
	5HR(10.2V)	116.5Ah
	1HR(9.6V)	87.3Ah
Dimension	Length	485 ± 2mm (19.09inch)
	Width	172 ± 2mm (6.77inch)
	Height	240 ± 2mm (9.45inch)
	Total Height	240 ± 2mm (9.45inch)
Approx. Weight		44kg (96.8lbs) ± 4%
Terminal type		T11
Internal resistance (Fully charged, 25°C)		Approx. 4.2m Ω
Capacity affected by temperature (10HR)	40°C	103%
	25°C	100%
	0°C	88%
	-15°C	70%
Self-discharge (25°C)	3 month	Remaining Capacity: 94%
	6 month	Remaining Capacity: 88%
	12 month	Remaining Capacity: 75%
Nominal operating temperature		25°C ± 3°C (77°F ± 5°F)
Operating temperature range	Discharge	-15°C ~ 55°C (5°F ~ 131°F)
	Charge	-10°C ~ 55°C (14°F ~ 131°F)
	Storage	-20°C ~ 55°C (-4°F ~ 131°F)
Float charging voltage(25°C)		13.50 to 13.80V Temperature compensation: -18mV/°C
Cyclic charging voltage(25°C)		14.10 to 14.40V Temperature compensation: -30mV/°C
Maximum charging current		30A
Terminal material		Copper
Maximum discharge current		1500A(5 sec.)
Designed floating life(20°C)		15 years

- ◆ Gelled electrolyte technology;
- ◆ PVC separator;
- ◆ Recognized by UL & CE;
- ◆ ABS container.

Constant Current Discharge Characteristics (A, 25°C)

F.V/TIME	15min	30min	60min	2h	3h	4h	5h	6h	8h	10h	20h	48h	120h
9.60V	203	140	87.3	51.0	36.0	28.3	23.7	20.2	15.8	14.0	7.67	---	---
9.90V	198	137	86.0	50.7	35.7	28.1	23.6	20.1	15.7	14.0	7.65	---	---
10.2V	190	133	83.8	50.3	35.5	27.9	23.4	19.9	15.6	14.0	7.63	3.35	---
10.5V	184	130	82.1	49.5	35.3	27.8	23.3	19.8	15.5	13.9	7.50	3.32	1.50
10.8V	174	125	79.6	48.2	34.2	26.9	22.6	19.2	15.0	13.8	7.53	3.32	1.50

Constant Power Discharge Characteristics (Watt, 25°C)

F.V/TIME	15min	30min	60min	2h	3h	4h	5h	6h	8h	10h	20h	48h	120h
9.60V	2260	1594	1006	594	425	335	282	240	188	169	92.4	---	---
9.90V	2206	1562	991	590	422	333	280	239	187	168	92.3	---	---
10.2V	2124	1514	965	585	420	330	278	237	186	168	92.0	40.1	---
10.5V	2052	1477	946	576	417	328	276	235	184	167	90.4	39.8	16.6
10.8V	1944	1423	917	562	404	318	268	228	179	166	90.8	39.8	16.5

Note: The above characteristics data can be obtained within three charge/discharge cycles.



Dimensions

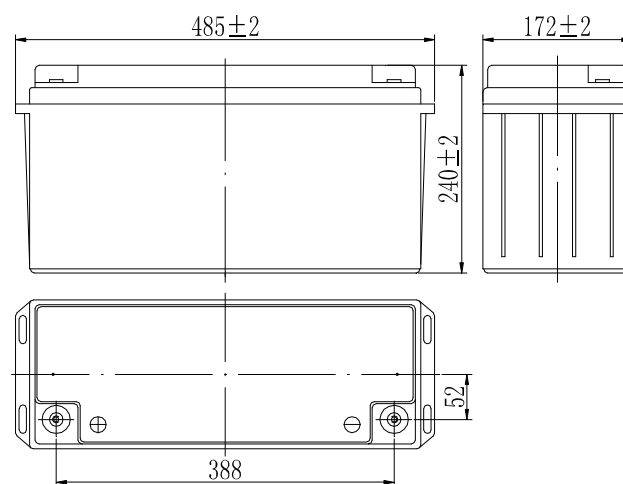

Terminal

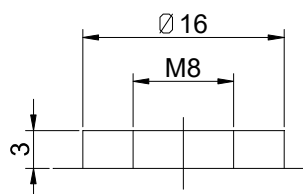

Terminal T11

Discharge Characteristics(25°C)

Charging Characteristics(25°C)

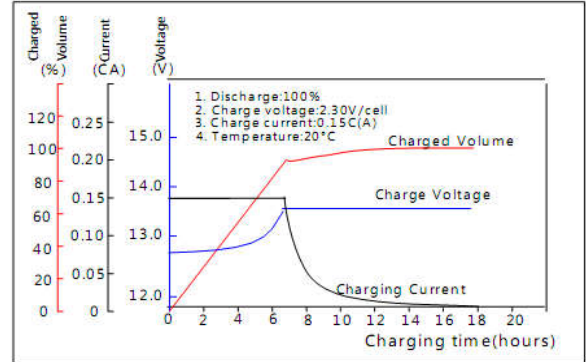
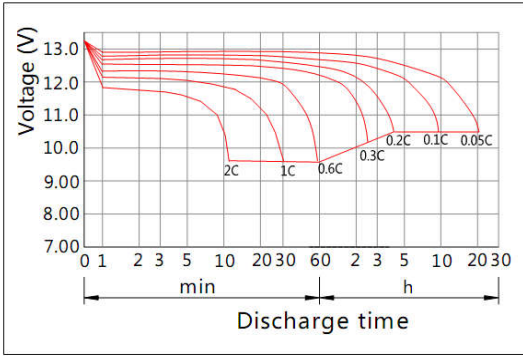

Effect of Temperature on Capacity

Self-discharge Characteristics

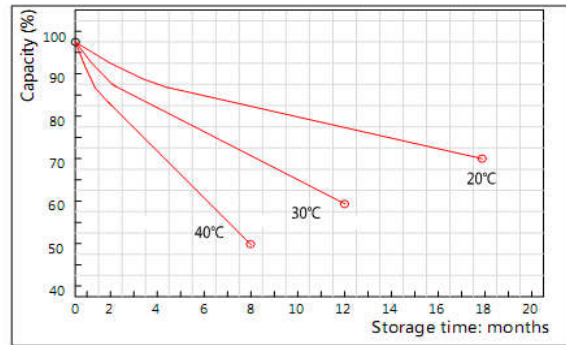
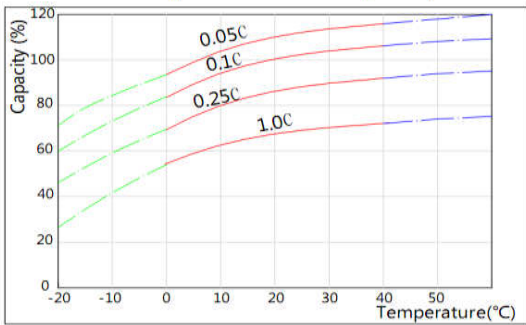

The Relationship for Open Circuit Voltage and Residual Capacity (25°C)

The Relationship for Charging Voltage and Temperature

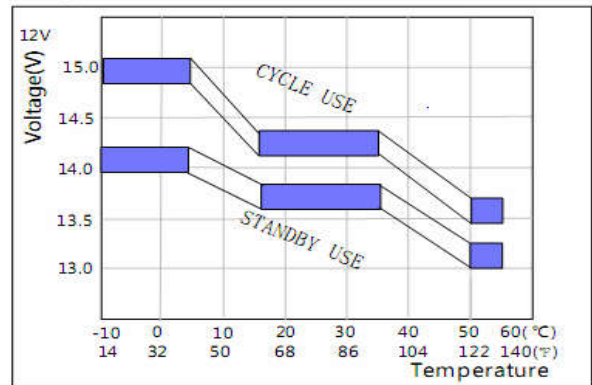
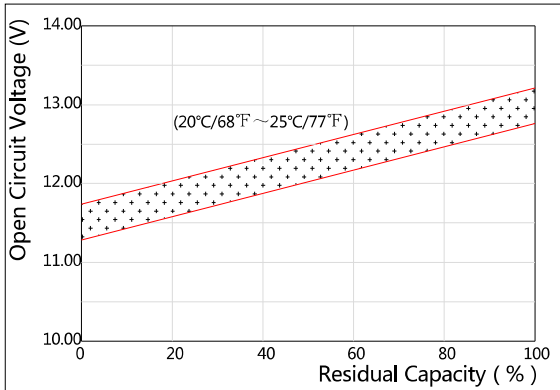

Floating Life on Temperature

Cycle Life on D.O.D(25°C)

