

**Specifications**

Nominal Voltage		12 V
Capacity (25°C)	20HR(10.5V)	100 Ah
	5HR(10.2V)	83Ah
	1HR(9.6V)	58.1Ah
Dimension	Length	506 ± 2mm (19.92inch)
	Width	110 ± 2mm (4.33inch)
	Height	224 ± 2mm (8.82inch)
	Total Height	239 ± 2mm (9.41inch)
Approx. Weight		31kg (68.2lbs) ± 4%
Terminal type		T9
Internal resistance (Fully charged, 25°C)		Approx. 5.4m Ω
Capacity affected by temperature (10HR)	40°C	103%
	25°C	100%
	0°C	88%
	-15°C	70%
Self-discharge (25°C)	3 month	Remaining Capacity: 94%
	6 month	Remaining Capacity: 88%
	12 month	Remaining Capacity: 75%
Nominal operating temperature		25°C ± 3°C (77°F ± 5°F)
Operating temperature range	Discharge	-15°C ~ 55°C (5°F ~ 131°F)
	Charge	-10°C ~ 55°C (14°F ~ 131°F)
	Storage	-20°C ~ 55°C (-4°F ~ 131°F)
Float charging voltage(25°C)		13.50 to 13.80V Temperature compensation: -18mV/°C
Cyclic charging voltage(25°C)		14.10 to 14.40V Temperature compensation: -30mV/°C
Maximum charging current		20A
Terminal material		Copper
Maximum discharge current		1000A(5 sec.)
Designed floating life(20°C)		15 years

- ◆ Gelled electrolyte technology;
- ◆ PVC separator;
- ◆ Recognized by UL & CE;
- ◆ ABS container.

**Constant Current Discharge Characteristics (A, 25°C)**

F.V/TIME	15min	30min	60min	2h	3h	4h	5h	6h	8h	10h	20h	48h	120h
9.60V	150	91.8	58.1	34.4	24.0	19.7	16.9	14.8	11.6	9.65	5.06	---	---
9.90V	146	89.9	57.2	34.2	23.8	19.6	16.8	14.7	11.5	9.58	5.04	---	---
10.2V	141	87.4	55.7	33.9	23.7	19.4	16.6	14.6	11.4	9.58	5.03	2.23	---
10.5V	136	84.9	54.6	33.4	23.5	19.3	16.6	14.5	11.3	9.52	5.00	2.22	0.92
10.8V	129	81.8	52.9	32.5	22.8	18.7	16.1	14.1	11.0	9.46	4.97	2.22	0.92

**Constant Power Discharge Characteristics (Watt, 25°C)**

F.V/TIME	15min	30min	60min	2h	3h	4h	5h	6h	8h	10h	20h	48h	120h
9.60V	1477	1051	663	394	282	222	188	160	125	112	61.6	---	---
9.90V	1441	1031	653	391	281	221	187	159	125	112	61.5	---	---
10.2V	1388	999	638	388	279	219	185	158	124	112	61.3	26.8	---
10.5V	1341	975	625	382	277	218	184	157	123	111	60.3	26.6	11.1
10.8V	1270	940	605	372	268	211	179	152	119	110	60.5	26.6	11.0

Note: The above characteristics data can be obtained within three charge/discharge cycles.



**Dimensions**

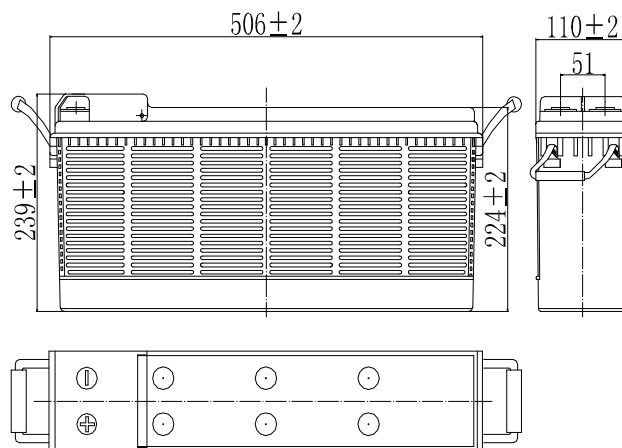

**Terminal**

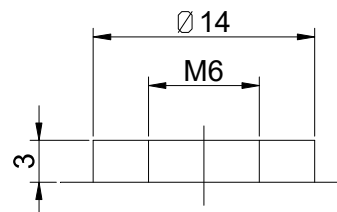

Terminal T9

Discharge Characteristics(25°C)

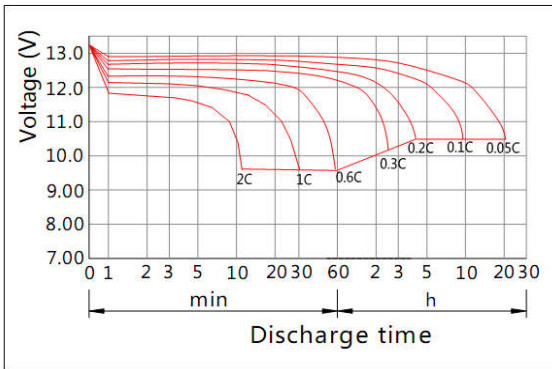

Charging Characteristics(25°C)

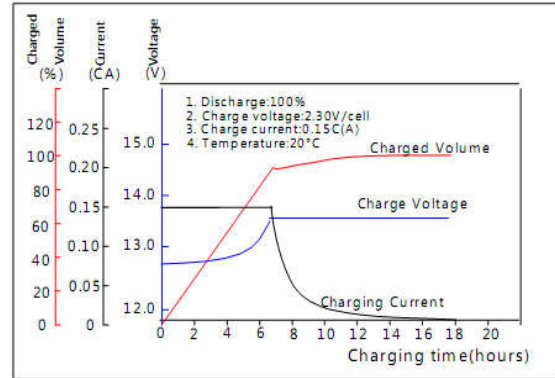

Effect of Temperature on Capacity

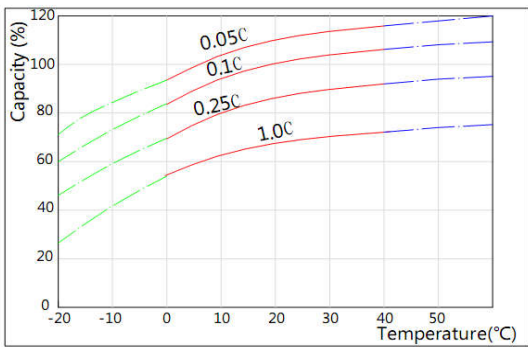

Self-discharge Characteristics

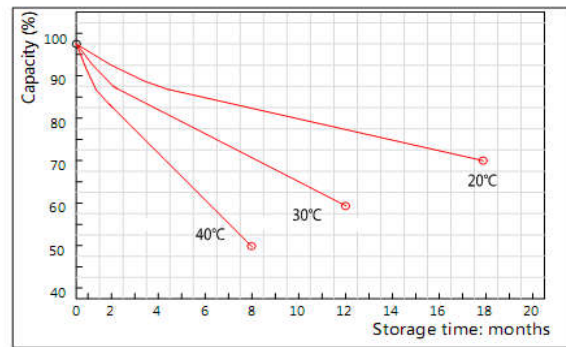

The Relationship for Open Circuit Voltage and Residual Capacity (25°C)

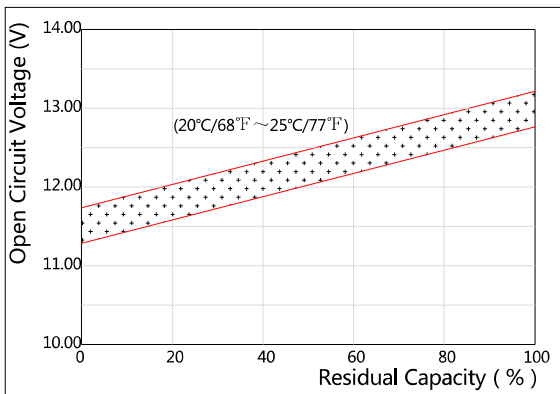

The Relationship for Charging Voltage and Temperature

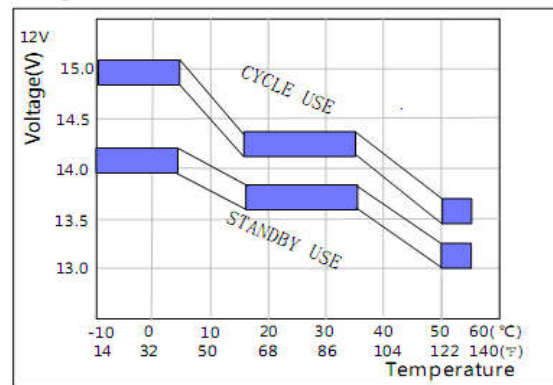

Floating Life on Temperature

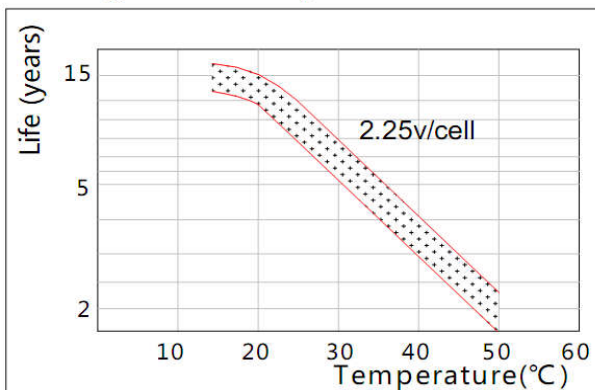

Cycle Life on D.O.D(25°C)

