

Specifications

Nominal Voltage		12 V
Capacity (25°C)	10HR(10.8V)	65 Ah
	5HR(10.5V)	57Ah
	1HR(9.60V)	40.3Ah
Dimension	Length	330 ± 2mm (12.99inch)
	Width	173 ± 2mm (6.81inch)
	Height	167 ± 2mm (6.57inch)
	Total Height	170 ± 2mm (6.69inch)
Approx. Weight		20.8kg (45.9lbs) ± 4%
Terminal type		T9
Internal resistance (Fully charged, 25°C)		Approx. 6m Ω
Capacity affected by temperature (10HR)	40°C	102%
	25°C	100%
	0°C	85%
	-15°C	65%
Self-discharge (25°C)	3 month	Remaining Capacity: 91%
	6 month	Remaining Capacity: 82%
	12 month	Remaining Capacity: 65%
Nominal operating temperature		25°C ± 3°C (77°F ± 5°F)
Operating temperature range	Discharge	-15°C ~ 50°C (5°F ~ 122°F)
	Charge	-10°C ~ 50°C (14°F ~ 122°F)
	Storage	-20°C ~ 50°C (-4°F ~ 122°F)
Float charging voltage(25°C)		13.50 to 13.80V Temperature compensation: -18mV/°C
Cyclic charging voltage(25°C)		14.50 to 14.90V Temperature compensation: -30mV/°C
Maximum charging current		19.5A
Terminal material		T17: Lead, T9: Copper
Maximum discharge current		650A(5 sec.)
Designed floating life(20°C)		12 years

- ◆ Absorbent glass mat technology;
- ◆ Recognized by UL & CE;
- ◆ ABS container.

Constant Current Discharge Characteristics (A, 25°C)

F.V/TIME	10min	15min	30min	60min	2h	3h	4h	5h	8h	10h	20h
9.60V	137	107	65.0	40.3	23.8	16.6	13.6	11.6	7.96	6.62	3.47
9.90V	132	105	63.7	39.7	23.6	16.5	13.5	11.5	7.91	6.60	3.47
10.2V	127	101	61.8	38.7	23.4	16.4	13.4	11.5	7.85	6.58	3.46
10.5V	121	97.4	60.3	37.9	23.0	16.3	13.3	11.4	7.80	6.55	3.44
10.8V	115	92.2	58.0	36.8	22.5	15.8	12.9	11.0	7.57	6.50	3.41

Constant Power Discharge Characteristics (Watt, 25°C)

F.V/TIME	10min	15min	30min	60min	2h	3h	4h	5h	8h	10h	20h
9.60V	1474	1178	729	459	275	195	160	137	94.5	79.0	41.7
9.90V	1430	1149	715	453	273	194	159	136	94.0	78.9	41.6
10.2V	1371	1107	693	441	271	192	158	135	93.3	78.6	41.5
10.5V	1312	1069	676	432	267	191	157	134	92.7	78.2	41.2
10.8V	1238	1013	651	419	260	185	152	130	89.9	77.6	41.0

Note: The above characteristics data can be obtained within three charge/discharge cycles.



Dimensions

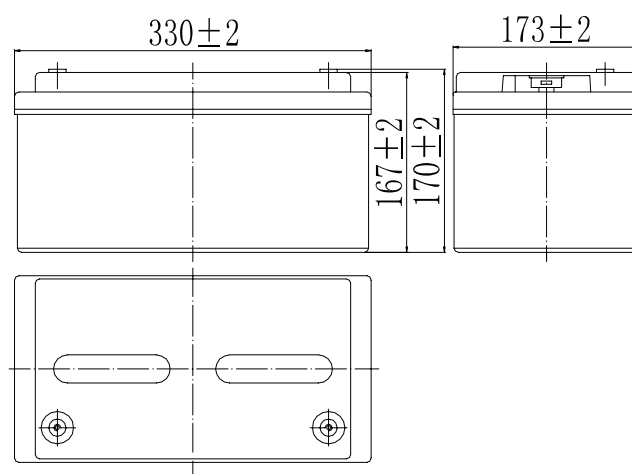

Terminal

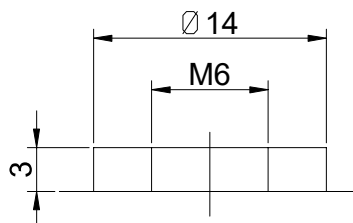

Terminal T9

Discharge Characteristics(25°C)

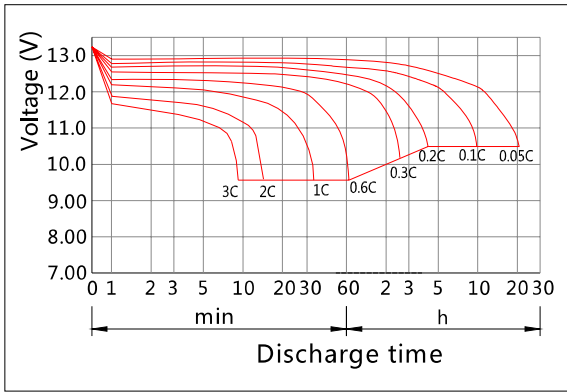

Charging Characteristics(25°C)

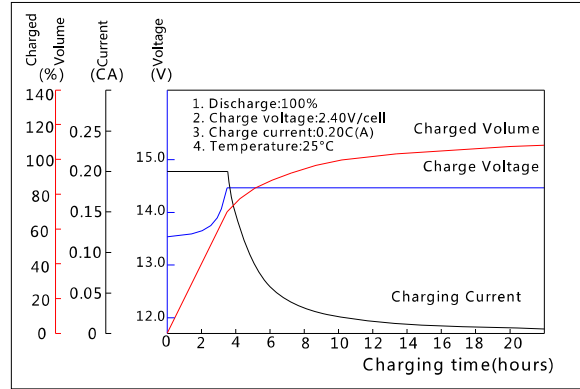

Effect of Temperature on Capacity

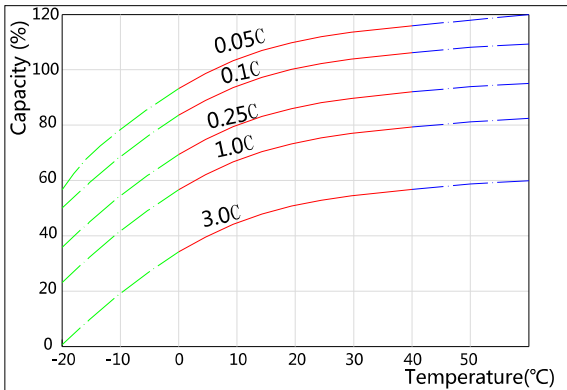

Self-discharge Characteristics

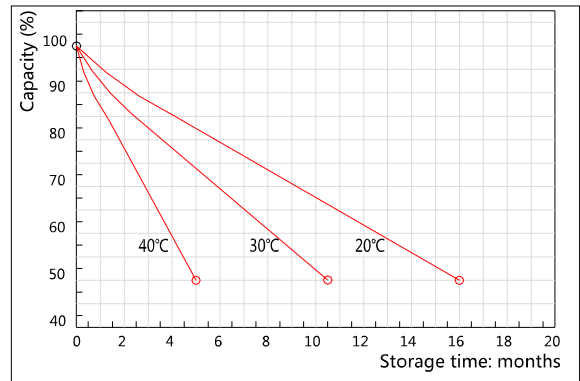

The Relationship for Open Circuit Voltage and Residual Capacity (25°C)

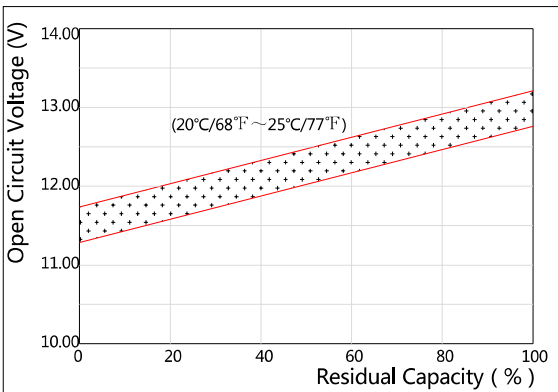

The Relationship for Charging Voltage and Temperature

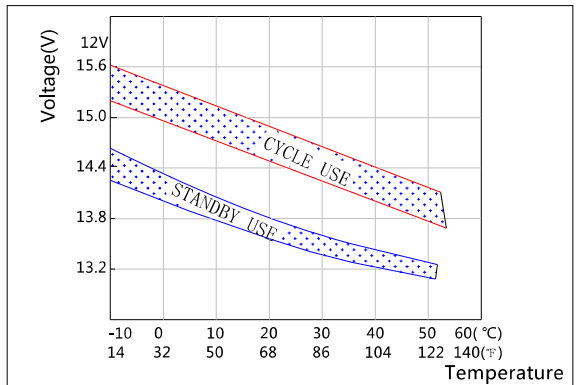

Floating Life on Temperature

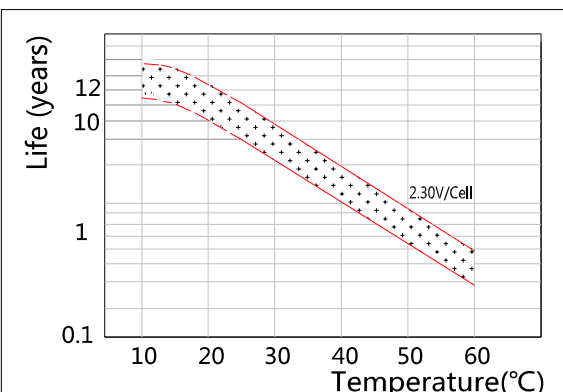

Cycle Life on D.O.D(25°C)

