

**Specifications**

Nominal Voltage		12 V
Capacity (25°C)	10HR(10.8V)	60 Ah
	5HR(10.5V)	52.5Ah
	1HR(9.60V)	37.2Ah
Dimension	Length	220 ± 2mm (8.66inch)
	Width	121 ± 1mm (4.76inch)
	Height	247 ± 2mm (9.72inch)
	Total Height	250 ± 2mm (9.84inch)
Approx. Weight		18.5kg (40.8lbs) ± 4%
Terminal type		T9
Internal resistance (Fully charged, 25°C)		Approx. 6m Ω
Capacity affected by temperature (10HR)	40°C	102%
	25°C	100%
	0°C	85%
	-15°C	65%
Self-discharge (25°C)	3 month	Remaining Capacity: 91%
	6 month	Remaining Capacity: 82%
	12 month	Remaining Capacity: 65%
Nominal operating temperature		25°C ± 3°C (77°F ± 5°F)
Operating temperature range	Discharge	-15°C ~ 50°C (5°F ~ 122°F)
	Charge	-10°C ~ 50°C (14°F ~ 122°F)
	Storage	-20°C ~ 50°C (-4°F ~ 122°F)
Float charging voltage(25°C)	13.50 to 13.80V Temperature compensation: -18mV/°C	
Cyclic charging voltage(25°C)	14.50 to 14.90V Temperature compensation: -30mV/°C	
Maximum charging current	18A	
Terminal material	Copper	
Maximum discharge current	600A (5 sec.)	
Designed floating life(20°C)	12 years	

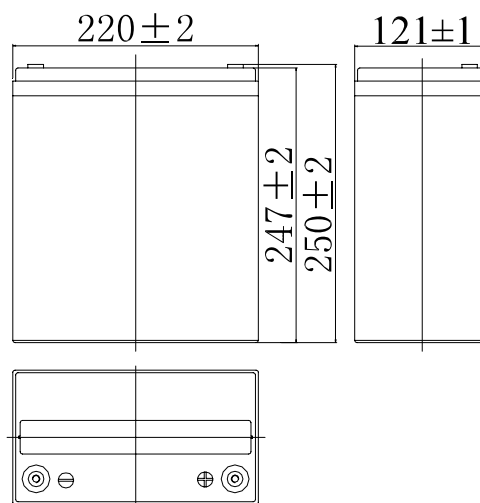

**Dimensions**



**Terminal**

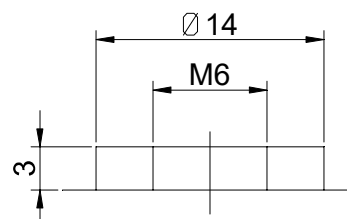

Terminal T9

- ◆ Absorbent glass mat technology;
- ◆ Recognized by UL & CE;
- ◆ ABS container.

**Constant Current Discharge Characteristics (A, 25°C)**

F.V/TIME	10min	15min	30min	60min	2h	3h	4h	5h	8h	10h	20h
9.60V	126	99.0	60.0	37.2	21.9	15.3	12.5	10.7	7.34	6.11	3.21
9.90V	122	96.6	58.8	36.6	21.8	15.2	12.5	10.6	7.30	6.10	3.20
10.2V	117	93.1	57.0	35.7	21.6	15.1	12.4	10.6	7.25	6.08	3.19
10.5V	112	89.9	55.6	35.0	21.3	15.0	12.3	10.5	7.20	6.04	3.17
10.8V	106	85.1	53.6	33.9	20.7	14.6	11.9	10.2	6.98	6.00	3.15

**Constant Power Discharge Characteristics (Watt, 25°C)**

F.V/TIME	10min	15min	30min	60min	2h	3h	4h	5h	8h	10h	20h
9.60V	1361	1087	673	424	254	180	148	127	87.2	72.9	38.5
9.90V	1320	1061	660	418	252	179	147	126	86.7	72.8	38.4
10.2V	1266	1022	640	407	250	178	146	125	86.1	72.6	38.3
10.5V	1211	987	624	399	246	176	145	124	85.5	72.1	38.1
10.8V	1143	935	601	387	240	171	140	120	83.0	71.6	37.8

Note: The above characteristics data can be obtained within three charge/discharge cycles.

**Discharge Characteristics(25°C)**

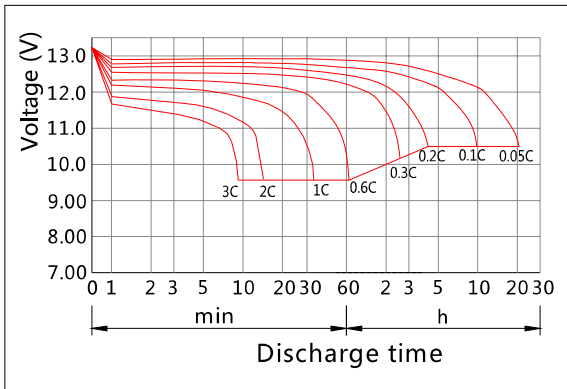

**Charging Characteristics(25°C)**

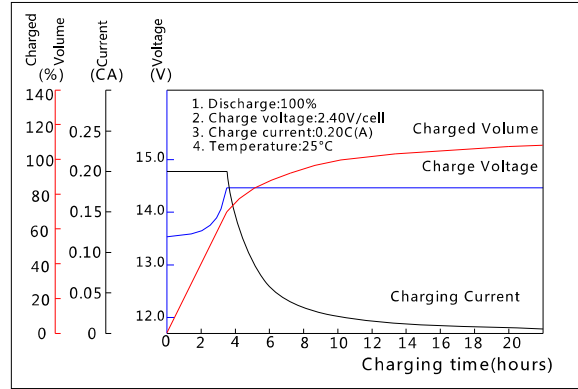

**Effect of Temperature on Capacity**

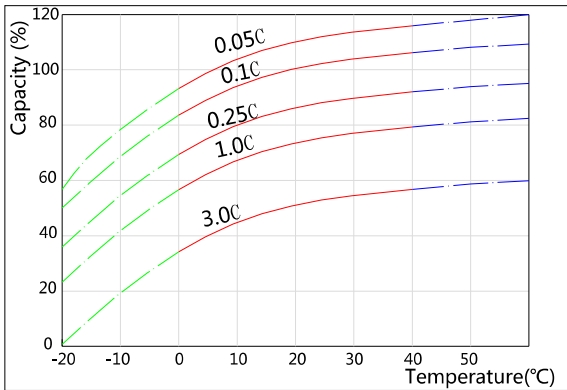

**Self-discharge Characteristics**

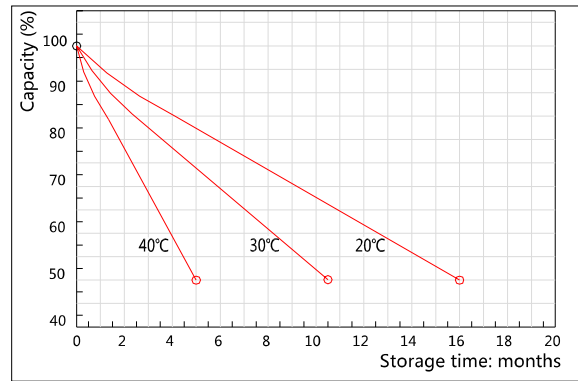

**The Relationship for Open Circuit Voltage and Residual Capacity (25°C)**

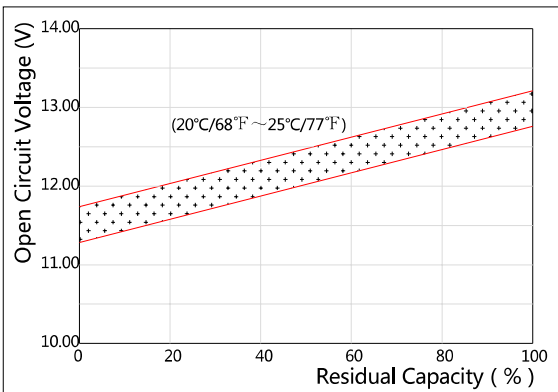

**The Relationship for Charging Voltage and Temperature**

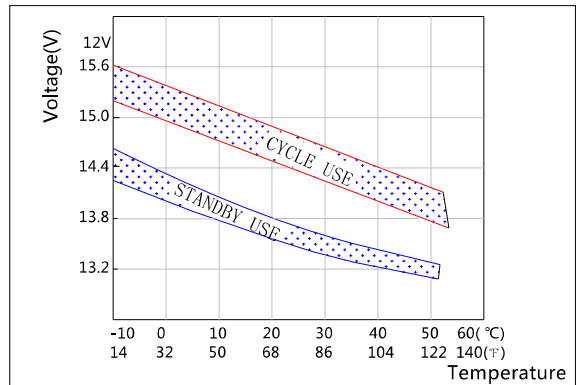

**Floating Life on Temperature**

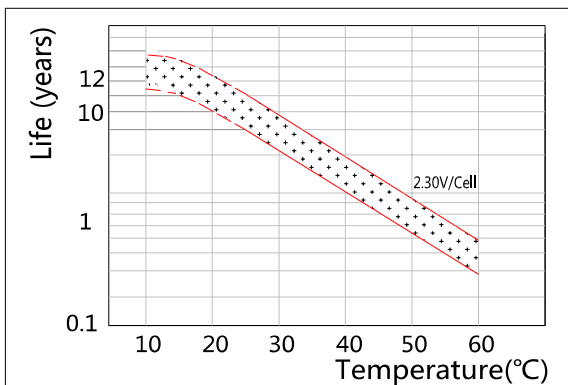

**Cycle Life on D.O.D(25°C)**

