

**Specifications**

Nominal Voltage		12 V
Capacity (25°C)	10HR(10.8V)	200 Ah
	5HR(10.5V)	175Ah
	1HR(9.60V)	124Ah
Dimension	Length	522 ± 2mm (20.55inch)
	Width	238 ± 2mm (9.37inch)
	Height	218 ± 2mm (8.58inch)
	Total Height	T5: 238 ± 2mm (9.37inch) T11: 221 ± 2mm (8.70inch)
Approx. Weight		65kg (143.3lbs) ± 3%
Terminal type		T5/T11
Internal resistance (Fully charged, 25°C)		Approx. 3m Ω
Capacity affected by temperature (10HR)	40°C	102%
	25°C	100%
	0°C	85%
	-15°C	65%
Self-discharge (25°C)	3 month	Remaining Capacity: 91%
	6 month	Remaining Capacity: 82%
	12 month	Remaining Capacity: 65%
Nominal operating temperature		25°C ± 3°C (77°F ± 5°F)
Operating temperature range	Discharge	-15°C ~ 50°C (5°F ~ 122°F)
	Charge	-10°C ~ 50°C (14°F ~ 122°F)
	Storage	-20°C ~ 50°C (-4°F ~ 122°F)
Float charging voltage(25°C)		13.50 to 13.80V Temperature compensation: -18mV/°C
Cyclic charging voltage(25°C)		14.50 to 14.90V Temperature compensation: -30mV/°C
Maximum charging current		60A
Terminal material		Copper
Maximum discharge current		1600A(5 sec.)
Designed floating life(20°C)		15 years

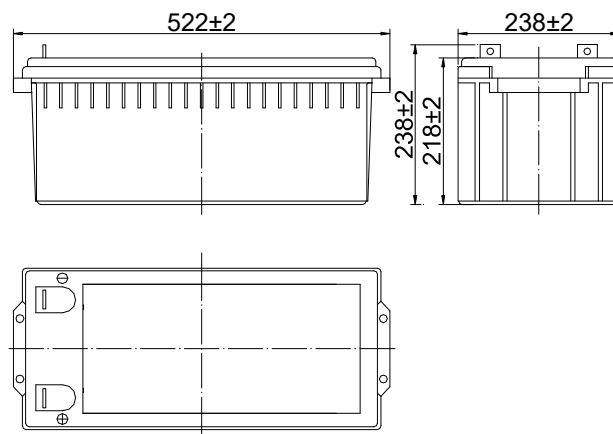

**Dimensions**



**Terminal**

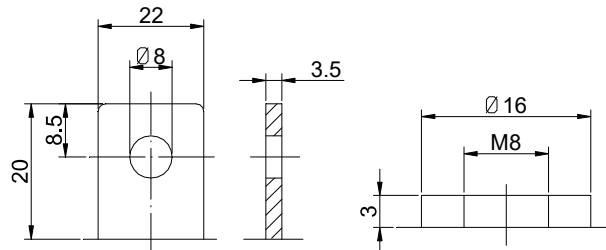

Terminal T5

Terminal T11

- ◆ Absorbent glass mat technology;
- ◆ Recognized by UL & CE;
- ◆ ABS container.

**Constant Current Discharge Characteristics (A, 25°C)**

F.V/TIME	15min	30min	60min	2h	3h	4h	5h	6h	8h	10h	20h
9.60V	323	196	124	73.1	51.0	41.8	35.7	31.2	24.5	20.4	10.7
9.90V	316	192	122	72.6	50.7	41.6	35.5	31.0	24.3	20.3	10.7
10.2V	304	186	119	72.0	50.4	41.3	35.2	30.8	24.2	20.3	10.6
10.5V	294	182	117	70.9	50.0	41.0	35.0	30.6	24.0	20.1	10.6
10.8V	278	175	113	69.1	48.5	39.8	34.0	29.7	23.3	20.0	10.5

**Constant Power Discharge Characteristics (Watt, 25°C)**

F.V/TIME	15min	30min	60min	2h	3h	4h	5h	6h	8h	10h	20h
9.60V	3551	2199	1414	846	600	492	422	369	291	243	128
9.90V	3466	2155	1392	841	596	489	419	367	289	243	128
10.2V	3338	2089	1357	834	592	486	417	364	287	242	128
10.5V	3224	2039	1330	821	588	482	414	362	285	240	127
10.8V	3054	1964	1289	800	570	468	401	351	277	239	126

Note: The above characteristics data can be obtained within three charge/discharge cycles.

Discharge Characteristics(25°C)

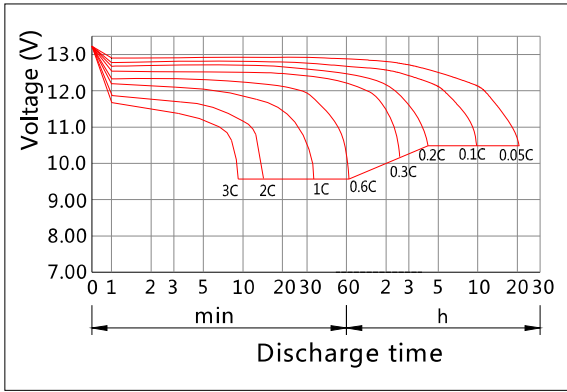

Characteristics(25°C)

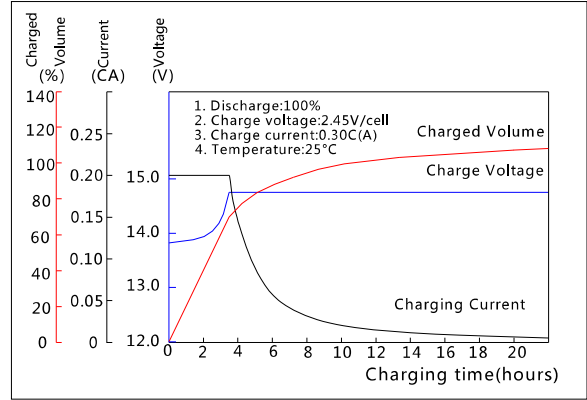

Effect of Temperature on Capacity

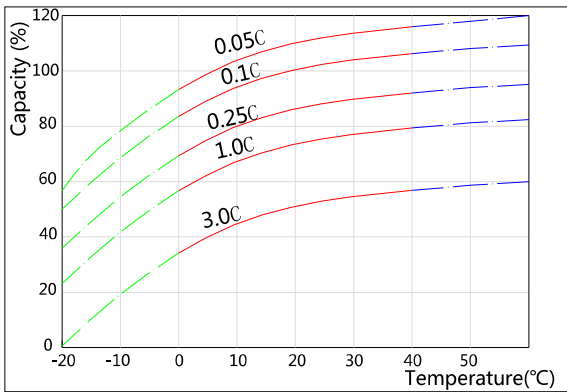

Self-discharge Characteristics

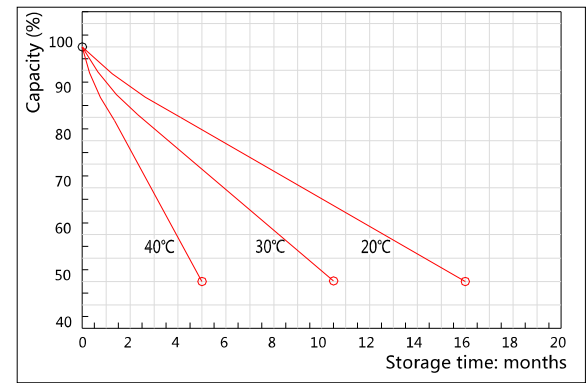

The Relationship for Open Circuit Voltage and Residual Capacity (25°C)

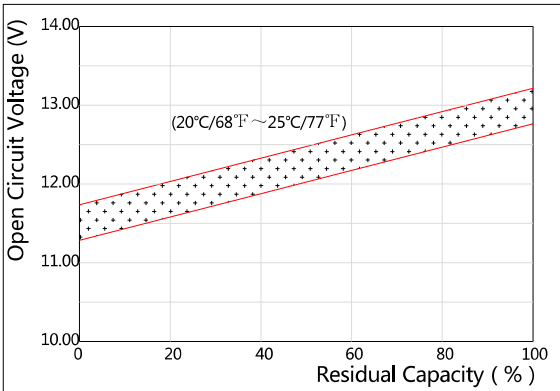

The Relationship for Charging Voltage and Temperature

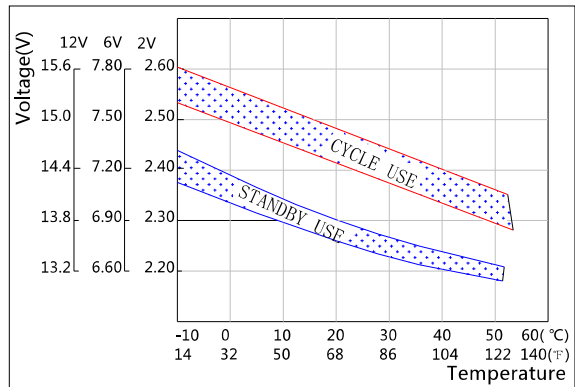

Floating Life on Temperature

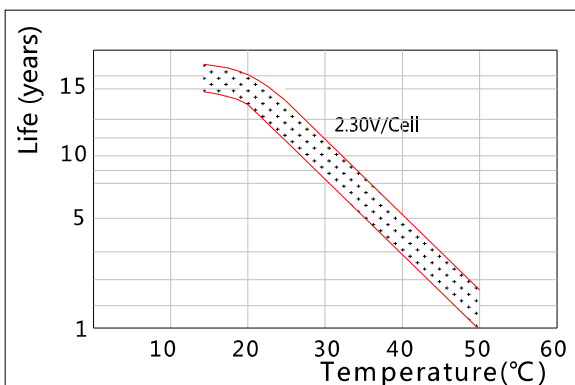

Cycle Life on D.O.D(25°C)

