

**Specifications**

Nominal Voltage		12 V
Capacity (25°C)	10HR(10.8V)	100 Ah
	5HR(10.5V)	87Ah
	1HR(9.60V)	62Ah
Dimension	Length	395 ± 2mm (15.55inch)
	Width	110 ± 2mm (4.33inch)
	Height	286 ± 2mm (11.26inch)
	Total Height	286 ± 2mm (11.26inch)
Approx. Weight		29.5kg (65.0lbs) ± 4%
Terminal type		T9
Internal resistance (Fully charged, 25°C)		Approx. 5m Ω
Capacity affected by temperature (10HR)	40°C	102%
	25°C	100%
	0°C	85%
	-15°C	65%
Self-discharge (25°C)	3 month	Remaining Capacity: 91%
	6 month	Remaining Capacity: 82%
	12 month	Remaining Capacity: 65%
Nominal operating temperature		25°C ± 3°C (77°F ± 5°F)
Operating temperature range	Discharge	-15°C ~ 50°C (5°F ~ 122°F)
	Charge	-10°C ~ 50°C (14°F ~ 122°F)
	Storage	-20°C ~ 50°C (-4°F ~ 122°F)
Float charging voltage(25°C)		13.50 to 13.80V Temperature compensation: -18mV/°C
Cyclic charging voltage(25°C)		14.50 to 14.90V Temperature compensation: -30mV/°C
Maximum charging current		30A
Terminal material		Copper
Maximum discharge current		800A(5 sec.)
Designed floating life(20°C)		15 years

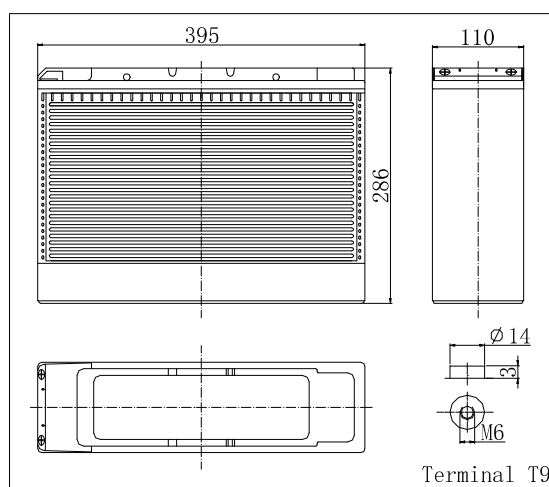

**Dimensions**



**Terminal**

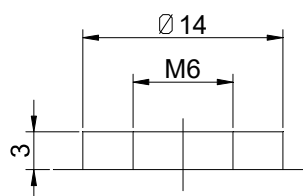

Terminal T9

- ◆ Absorbent glass mat technology;
- ◆ Recognized by UL & CE;
- ◆ ABS container.

**Constant Current Discharge Characteristics (A, 25°C)**

F.V/TIME	15min	30min	60min	2h	3h	4h	5h	6h	8h	10h	20h
9.60V	162	98.0	62.0	36.5	25.5	20.9	17.9	15.6	12.2	10.2	5.34
9.90V	158	96.0	61.1	36.3	25.4	20.8	17.7	15.5	12.2	10.2	5.33
10.2V	152	93.1	59.5	36.0	25.2	20.6	17.6	15.4	12.1	10.1	5.32
10.5V	147	90.8	58.3	35.5	25.0	20.5	17.5	15.3	12.0	10.1	5.29
10.8V	139	87.5	56.5	34.6	24.3	19.9	17.0	14.8	11.6	10.0	5.25

**Constant Power Discharge Characteristics (Watt, 25°C)**

F.V/TIME	15min	30min	60min	2h	3h	4h	5h	6h	8h	10h	20h
9.60V	1775	1100	707	423	300	246	211	184	145	122	64.1
9.90V	1733	1078	696	421	298	244	210	183	145	121	64.0
10.2V	1669	1045	679	417	296	243	208	182	144	121	63.8
10.5V	1612	1019	665	411	294	241	207	181	143	120	63.4
10.8V	1527	982	645	400	285	234	201	175	138	119	63.0

Note: The above characteristics data can be obtained within three charge/discharge cycles.

Discharge Characteristics(25°C)

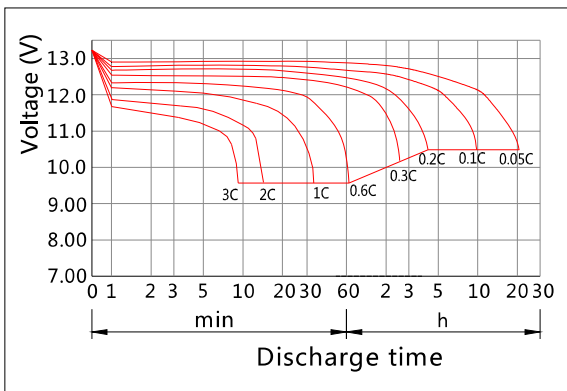

Characteristics(25°C)

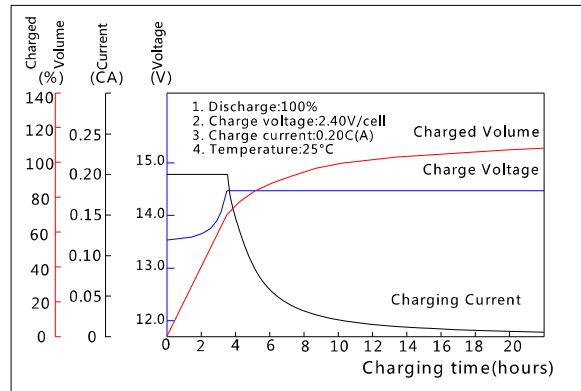

Effect of Temperature on Capacity

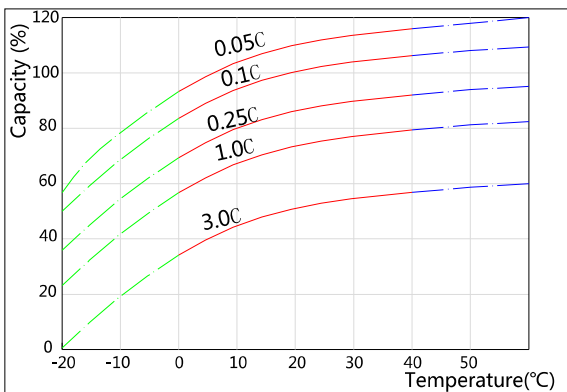

Self-discharge Characteristics

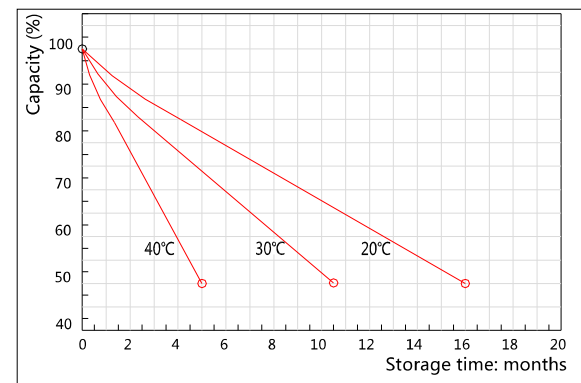

The Relationship for Open Circuit Voltage and Residual Capacity (25°C)

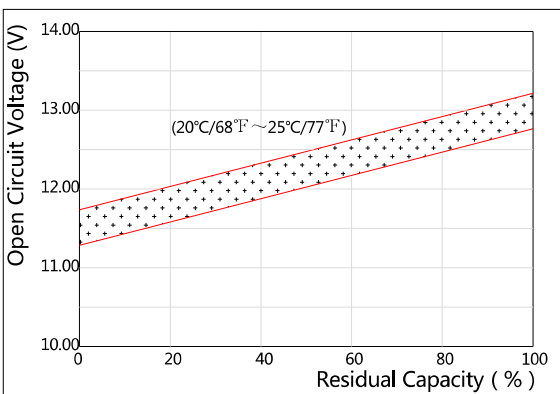

The Relationship for Charging Voltage and Temperature

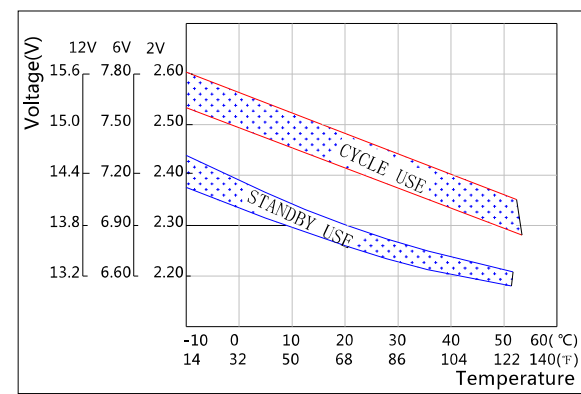

Floating Life on Temperature

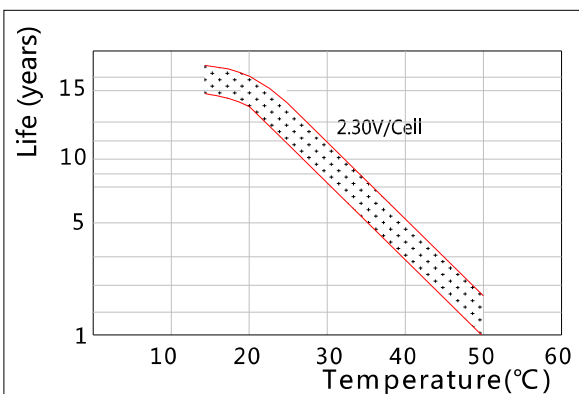

Cycle Life on D.O.D.(25°C)

