

**Specifications**

Nominal Voltage		12 V
Capacity (25°C)	20HR(10.5V)	6Ah
	10HR(10.5V)	5.6Ah
	1HR(9.60V)	3.9Ah
Dimension	Length	90 ± 1mm (3.54inch)
	Width	70 ± 1mm (2.76inch)
	Height	101 ± 1mm (3.98inch)
	Total Height	107 ± 1mm (4.21inch)
Approx. Weight		1.75kg (3.85lbs) ± 5%
Terminal type		T1/T2
Internal resistance (Fully charged, 25°C)		Approx. 22mΩ
Capacity affected by temperature (20HR)	40°C	102%
	25°C	100%
	0°C	85%
	-15°C	65%
Self-discharge (25°C)	3 month	Remaining Capacity: 91%
	6 month	Remaining Capacity: 82%
	12 month	Remaining Capacity: 65%
Nominal operating temperature		25°C ± 3°C (77°F ± 5°F)
Operating temperature range	Discharge	-15°C ~ 50°C (5°F ~ 122°F)
	Charge	-10°C ~ 50°C (14°F ~ 122°F)
	Storage	-20°C ~ 50°C (-4°F ~ 122°F)
Float charging voltage(25°C)		13.60 to 13.80V Temperature compensation: -18mV/°C
Cyclic charging voltage(25°C)		14.50 to 14.90V Temperature compensation: -30mV/°C
Maximum charging current		1.8A
Terminal material		Copper
Maximum discharge current		90A(5 sec.)
Designed floating life(20°C)		10years

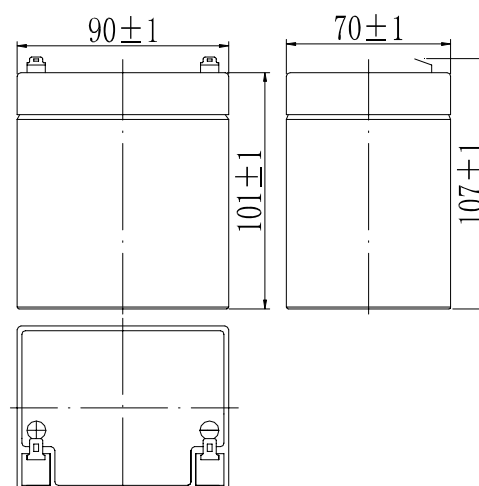

**Dimensions**



**Terminal**

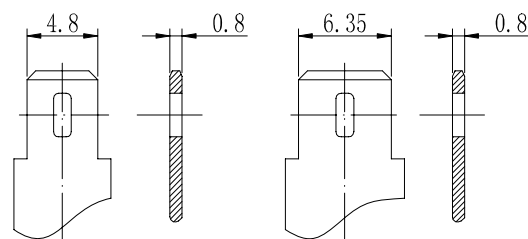

Terminal T1

Terminal T2

- ◆ Absorbent glass mat technology;
- ◆ Recognized by UL & CE;
- ◆ ABS container.

**Constant Current Discharge Characteristics (A, 25°C)**

F.V/TIME	5min	10min	15min	30min	60min	2h	3h	4h	5h	10h	20h
9.60V	22.8	14.4	11.4	6.36	3.90	2.13	1.53	1.22	1.04	0.57	0.30
9.90V	22.1	14.0	11.1	6.23	3.84	2.12	1.52	1.22	1.03	0.56	0.30
10.2V	21.2	13.4	10.7	6.04	3.74	2.10	1.51	1.21	1.03	0.56	0.30
10.5V	20.3	12.8	10.4	5.90	3.67	2.07	1.50	1.20	1.02	0.56	0.30
10.8V	19.2	12.1	9.80	5.68	3.56	2.02	1.46	1.16	0.99	0.55	0.29

**Constant Power Discharge Characteristics (Watt, 25°C)**

F.V/TIME	5min	10min	15min	30min	60min	2h	3h	4h	5h	10h	20h
9.60V	254	162	130	72.9	45.2	24.9	18.2	14.6	12.4	6.80	3.65
9.90V	247	158	127	71.4	44.5	24.8	18.1	14.5	12.3	6.77	3.64
10.2V	237	151	122	69.2	43.4	24.6	17.9	14.4	12.3	6.74	3.62
10.5V	226	145	118	67.6	42.5	24.2	17.8	14.3	12.2	6.70	3.60
10.8V	214	136	112	65.1	41.2	23.6	17.3	13.9	11.81	6.56	3.53

Note: The above characteristics data can be obtained within three charge/discharge cycles.

**Discharge Characteristics(25°C)**

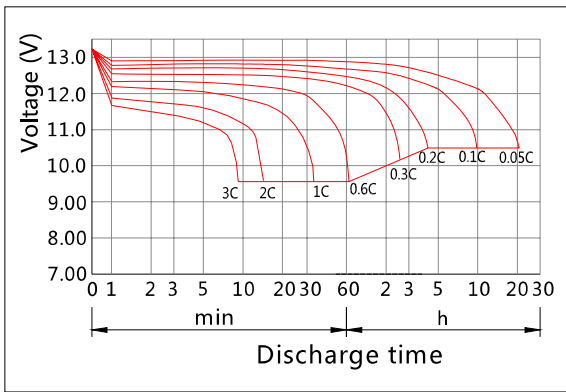

**Charging Characteristics(25°C)**

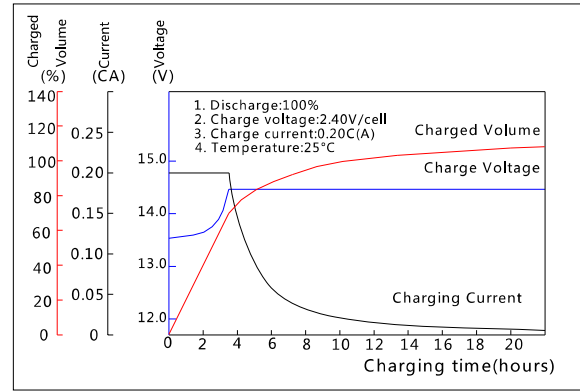

**Effect of Temperature on Capacity**

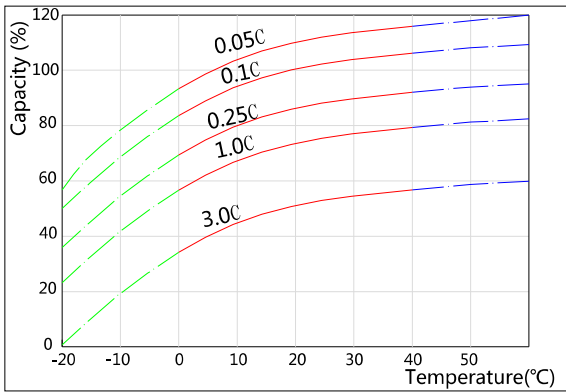

**Self-discharge Characteristics**

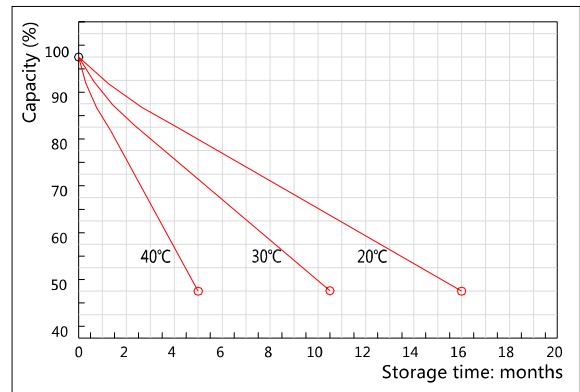

**The Relationship for Open Circuit Voltage and Residual Capacity (25°C)**

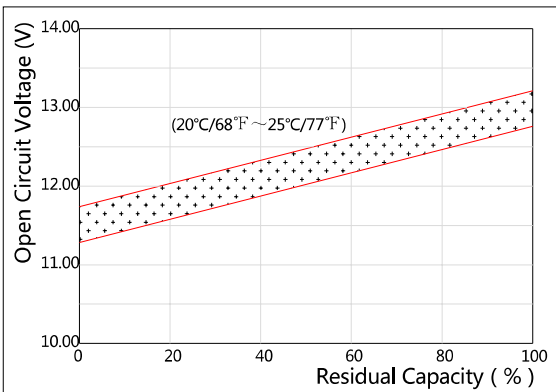

**The Relationship for Charging Voltage and Temperature**

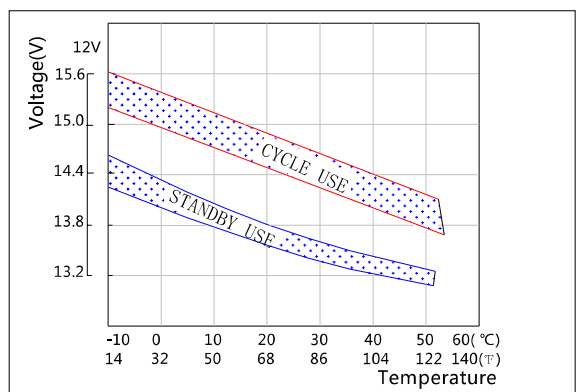

**Floating Life on Temperature**

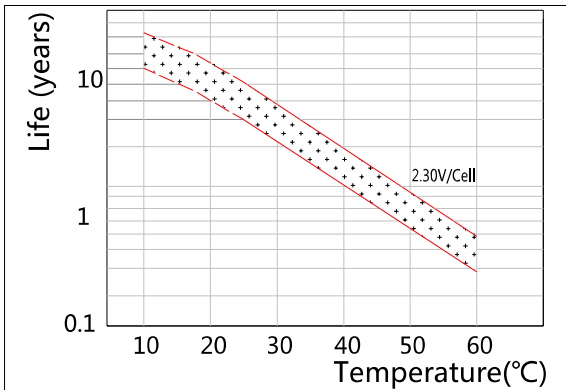

**Cycle Life on D.O.D(25°C)**

