

Specifications

Nominal Voltage		12 V
Capacity (25°C)	20HR(10.5V)	10Ah
	10HR(10.5V)	9.3Ah
	1HR(9.60V)	6.5Ah
Dimension	Length	151 ± 1.5mm (5.94inch)
	Width	65 ± 1mm (2.56inch)
	Height	111 ± 1mm (4.37inch)
	Total Height	117 ± 1mm (4.61inch)
Approx. Weight		2.75kg (6.05lbs) ± 5%
Terminal type		T2/T1
Internal resistance (Fully charged, 25°C)		Approx. 19mΩ
Capacity affected by temperature (20HR)	40°C	102%
	25°C	100%
	0°C	85%
	-15°C	65%
Self-discharge (25°C)	3 month	Remaining Capacity: 91%
	6 month	Remaining Capacity: 82%
	12 month	Remaining Capacity: 65%
Nominal operating temperature		25°C ± 3°C (77°F ± 5°F)
Operating temperature range	Discharge	-15°C ~ 50°C (5°F ~ 122°F)
	Charge	-10°C ~ 50°C (14°F ~ 122°F)
	Storage	-20°C ~ 50°C (-4°F ~ 122°F)
Float charging voltage(25°C)		13.60 to 13.80V Temperature compensation: -18mV/°C
Cyclic charging voltage(25°C)		14.50 to 14.90V Temperature compensation: -30mV/°C
Maximum charging current		3.0A
Terminal material		Copper
Maximum discharge current		150A(5 sec.)
Designed floating life(20°C)		10years

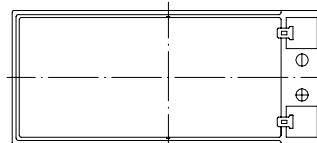

Dimensions

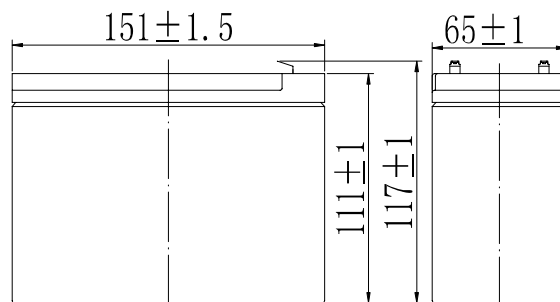

Terminal

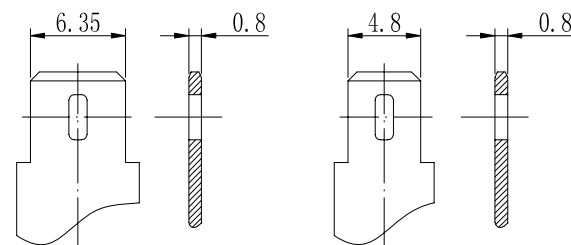

Terminal T2

Terminal T1

- ◆ Absorbent glass mat technology;
- ◆ Recognized by UL & CE;
- ◆ ABS container.

Constant Current Discharge Characteristics (A, 25°C)

F.V/TIME	10min	15min	30min	60min	2h	3h	4h	5h	8h	10h	20h
9.60V	24.0	19.0	10.6	6.50	3.55	2.55	2.04	1.73	1.12	0.94	0.51
9.90V	23.3	18.5	10.4	6.40	3.53	2.54	2.03	1.72	1.12	0.94	0.51
10.2V	22.3	17.9	10.1	6.24	3.50	2.52	2.01	1.71	1.11	0.94	0.50
10.5V	21.4	17.3	9.83	6.12	3.45	2.50	2.00	1.70	1.10	0.93	0.50
10.8V	20.2	16.3	9.47	5.93	3.36	2.43	1.94	1.65	1.07	0.91	0.49

Constant Power Discharge Characteristics (Watt, 25°C)

F.V/TIME	10min	15min	30min	60min	2h	3h	4h	5h	8h	10h	20h
9.60V	271	217	121	75.3	41.6	30.3	24.3	20.7	13.5	11.3	6.09
9.90V	263	211	119	74.1	41.3	30.1	24.2	20.6	13.4	11.3	6.07
10.2V	252	204	115	72.3	41.0	29.9	24.0	20.4	13.3	11.2	6.04
10.5V	241	197	113	70.8	40.3	29.7	23.8	20.3	13.2	11.2	6.00
10.8V	227	186	108	68.6	39.3	28.8	23.1	19.7	12.8	10.9	5.88

Note: The above characteristics data can be obtained within three charge/discharge cycles.

Discharge Characteristics(25°C)

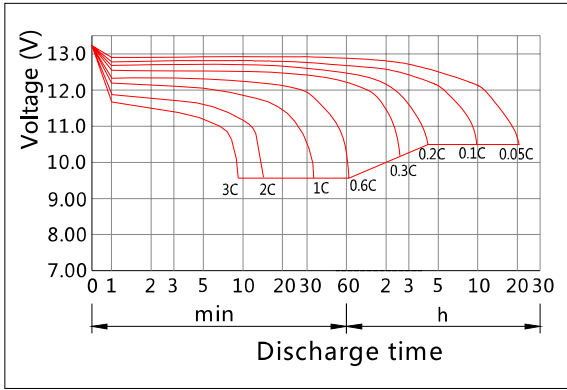

Charging Characteristics(25°C)

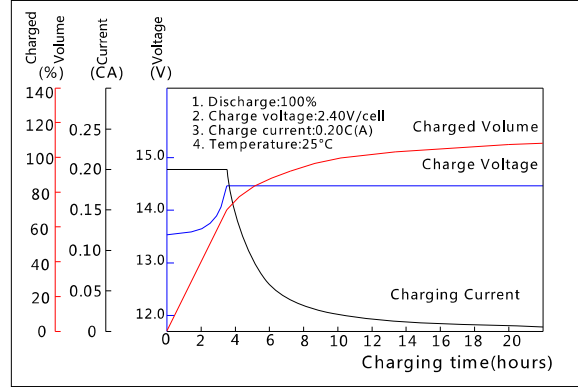

Effect of Temperature on Capacity

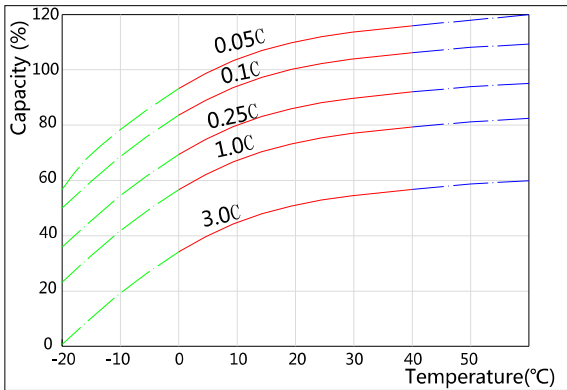

Self-discharge Characteristics

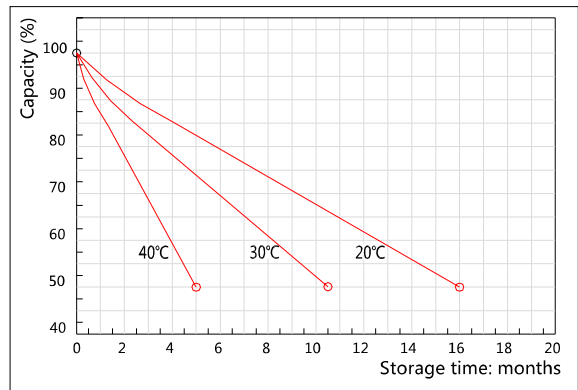

The Relationship for Open Circuit Voltage and Residual Capacity (25°C)

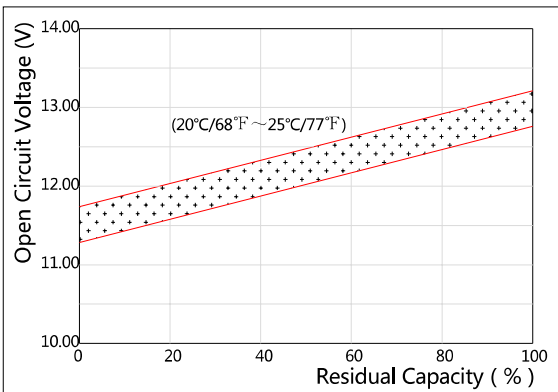

The Relationship for Charging Voltage and Temperature

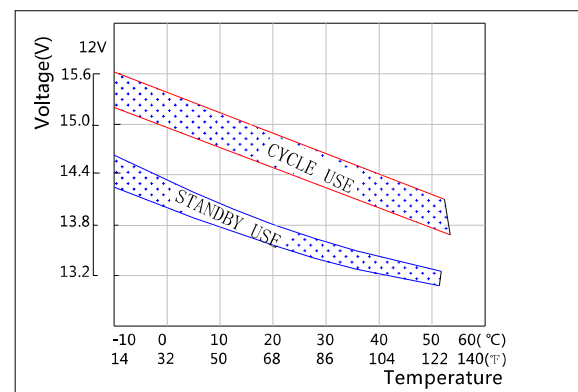

Floating Life on Temperature

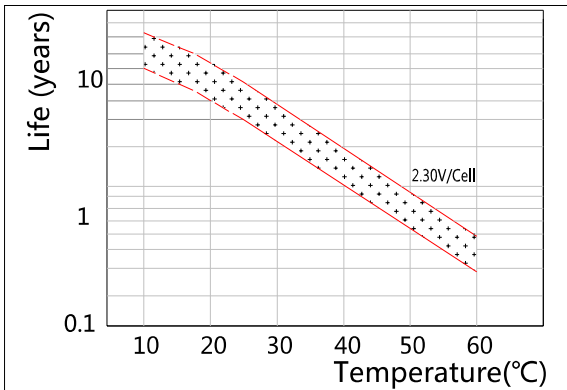

Cycle Life on D.O.D(25°C)

