

Specifications

Nominal Voltage		2 V
Capacity (25°C)	10HR(1.80V)	600 Ah
	3HR(1.75V)	535Ah
	1HR(1.60V)	360Ah
Dimension	Length	302 ± 2mm (11.89inch)
	Width	175 ± 2mm (6.89inch)
	Height	330 ± 2mm (12.99inch)
	Total Height	367 ± 2mm (14.45inch)
Approx. Weight		38kg (83.6lbs) ± 3%
Terminal type		T10
Internal resistance (Fully charged, 25°C)		Approx. 0.50m Ω
Capacity affected by temperature (10HR)	40°C	103%
	25°C	100%
	0°C	88%
	-15°C	70%
Self-discharge (25°C)	3 month	Remaining Capacity: 94%
	6 month	Remaining Capacity: 88%
	12 month	Remaining Capacity: 75%
Nominal operating temperature		25°C ± 3°C (77°F ± 5°F)
Operating temperature range	Discharge	-15°C ~ 55°C (5°F ~ 131°F)
	Charge	-10°C ~ 55°C (14°F ~ 131°F)
	Storage	-20°C ~ 55°C (-4°F ~ 131°F)
Float charging voltage(25°C)	2.25 to 2.30V Temperature compensation: -3mV/°C	
Cyclic charging voltage(25°C)	2.35 to 2.40V Temperature compensation: -5mV/°C	
Maximum charging current	120A	
Terminal material	Copper	
Maximum discharge current	3000A(5 sec.)	
Designed floating life(20°C)	20 years	

- ◆ Gelled electrolyte technology;
- ◆ PVC separator;
- ◆ Recognized by UL & CE;
- ◆ ABS container.

Constant Current Discharge Characteristics (A, 25°C)

F.V/TIME	30min	60min	2h	3h	4h	5h	6h	8h	10h	20h	48h	120h
1.60V	510	360	221	156	126	109	93.6	73.2	61.2	32.3	---	---
1.65V	503	354	217	156	125	108	93.0	73.2	61.2	32.3	--	--
1.70V	491	347	216	155	124	107	92.4	72.6	60.6	31.8	14.6	---
1.75V	480	341	215	154	124	107	91.8	72.0	60.6	31.8	14.6	6.06
1.80V	467	329	209	149	119	104	88.8	69.6	60.0	31.7	14.5	6.00

Constant Power Discharge Characteristics (Watt, 25°C)

F.V/TIME	30min	60min	2h	3h	4h	5h	6h	8h	10h	20h	48h	120h
1.60V	954	684	425	306	246	215	185	146	122	64.2	---	---
1.65V	936	672	420	305	245	215	184	145	121	64.2	--	--
1.70V	918	654	419	300	245	211	184	144	121	63.6	29.9	---
1.75V	900	642	408	300	241	210	180	144	120	63.6	29.5	12.4
1.80V	870	624	401	293	234	204	175	139	119	63.0	29.4	12.3

Note: The above characteristics data can be obtained within three charge/discharge cycles.



Dimensions

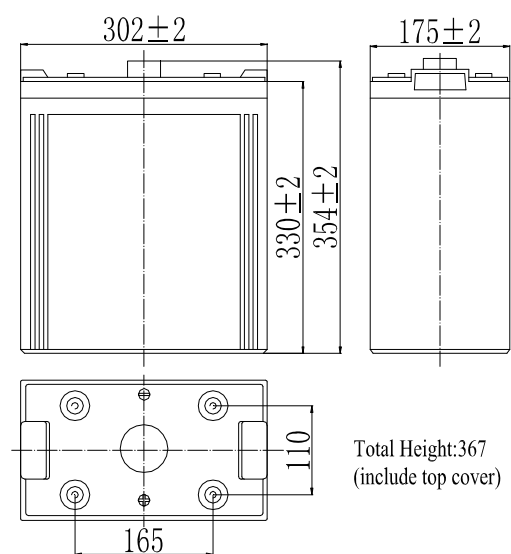

Total Height:367 (include top cover)

Terminal

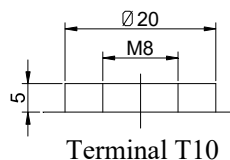

Terminal T10

Discharge Characteristics(25°C)

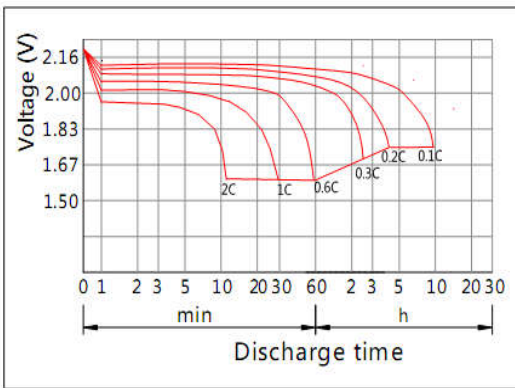

Charging Characteristics(25°C)

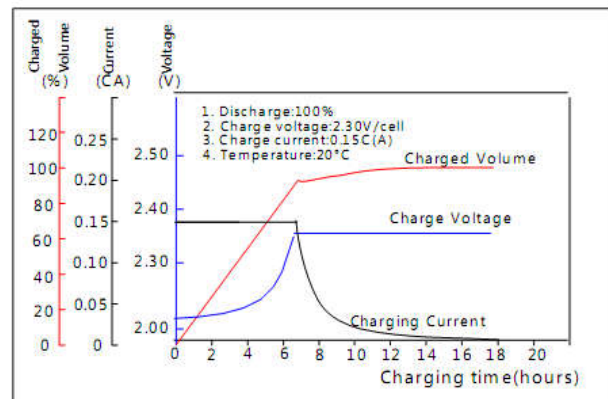

Effect of Temperature on Capacity

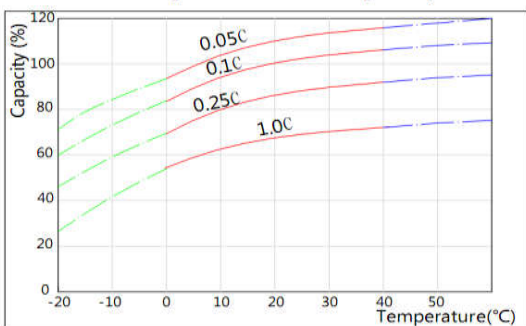

Self-discharge Characteristics

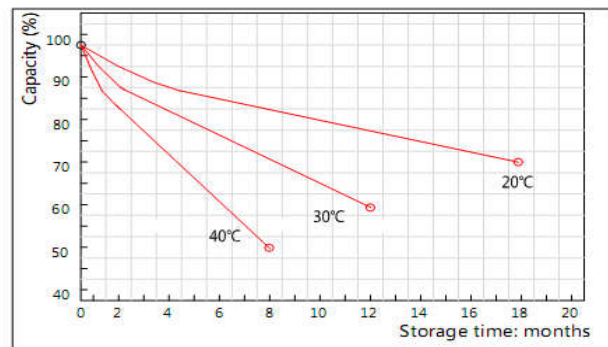

The Relationship for Open Circuit Voltage and Residual Capacity (25°C)

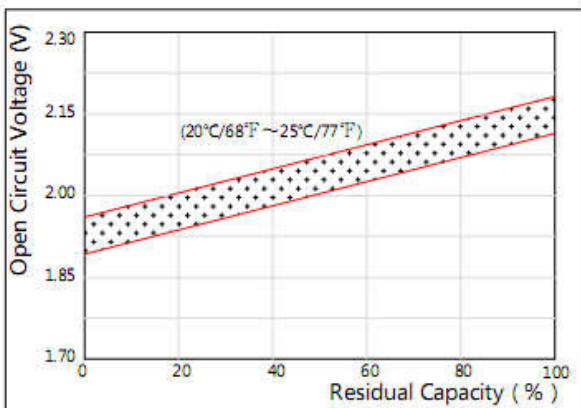

The Relationship for Charging Voltage and Temperature

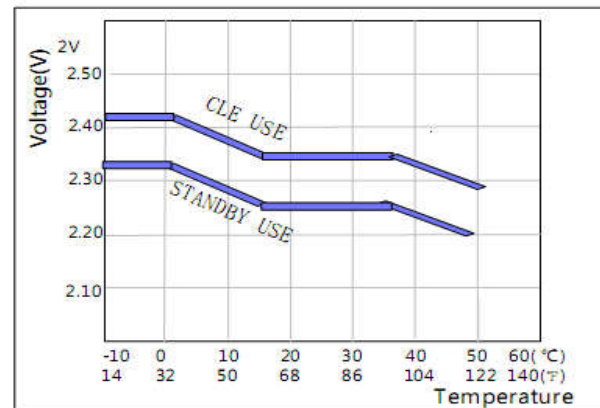

Floating Life on Temperature

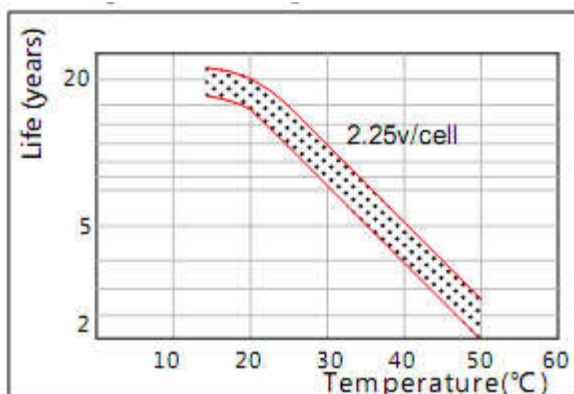

Cycle Life on D.O.D(25°C)

