

Specifications

Nominal Voltage		2 V
Capacity (25°C)	10HR(1.80V)	300 Ah
	3HR(1.75V)	230Ah
	1HR(1.60V)	180Ah
Dimension	Length	171 ± 2mm (6.73inch)
	Width	151 ± 2mm (5.94inch)
	Height	330 ± 2mm (12.99inch)
	Total Height	364 ± 2mm (14.33inch)
Approx. Weight		19.5kg (42.9lbs) ± 3%
Terminal type		T10
Internal resistance (Fully charged, 25°C)		Approx. 0.8m Ω
Capacity affected by temperature (10HR)	40°C	103%
	25°C	100%
	0°C	88%
	-15°C	70%
Self-discharge (25°C)	3 month	Remaining Capacity: 94%
	6 month	Remaining Capacity: 88%
	12 month	Remaining Capacity: 75%
Nominal operating temperature		25°C ± 3°C (77°F ± 5°F)
Operating temperature range	Discharge	-15°C ~ 55°C (5°F ~ 131°F)
	Charge	-10°C ~ 55°C (14°F ~ 131°F)
	Storage	-20°C ~ 55°C (-4°F ~ 131°F)
Float charging voltage(25°C)	2.25 to 2.30V Temperature compensation: -3mV/°C	
Cyclic charging voltage(25°C)	2.35 to 2.40V Temperature compensation: -5mV/°C	
Maximum charging current	60A	
Terminal material	Copper	
Maximum discharge current	1500A(5 sec.)	
Designed floating life(20°C)	20 years	

- ◆ Gelled electrolyte technology;
- ◆ PVC separator;
- ◆ Recognized by UL & CE;
- ◆ ABS container.

Constant Current Discharge Characteristics (A, 25°C)

F.V/TIME	30min	60min	2h	3h	4h	5h	6h	8h	10h	20h	48h	120h
1.60V	255	180	110	78.0	62.7	54.6	46.8	36.6	30.6	16.1	---	---
1.65V	251	177	109	77.7	62.4	54.0	46.5	36.6	30.6	16.1	--	--
1.70V	245	173	108	77.1	61.8	53.7	46.2	36.3	30.3	15.9	7.32	---
1.75V	240	170	107	76.5	61.5	53.4	45.9	36.0	30.3	15.9	7.32	3.03
1.80V	233	164	104	74.1	59.7	51.9	44.4	34.8	30.0	15.8	7.26	3.00

Constant Power Discharge Characteristics (Watt, 25°C)

F.V/TIME	30min	60min	2h	3h	4h	5h	6h	8h	10h	20h	48h	120h
1.60V	477	342	212	153	123	107	92.1	73.2	60.9	32.1	---	---
1.65V	468	336	210	152	122	107	91.8	72.6	60.6	32.1	--	--
1.70V	459	327	209	150	122	106	91.2	72.0	60.6	31.8	14.9	---
1.75V	450	321	204	150	121	105	90.3	71.7	60.0	31.8	14.8	6.18
1.80V	435	312	200	146	117	102	87.6	69.6	59.7	31.5	14.7	6.15

Note: The above characteristics data can be obtained within three charge/discharge cycles.



Dimensions

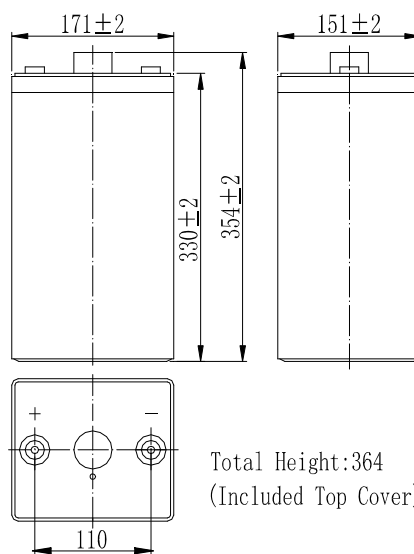

Terminal

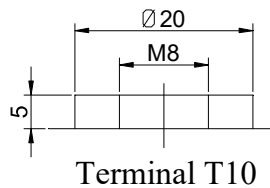

Discharge Characteristics(25°C)

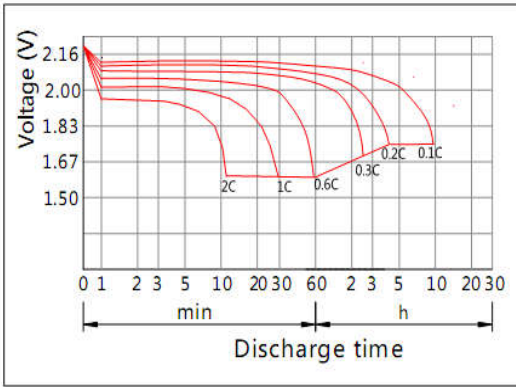

Charging Characteristics(25°C)

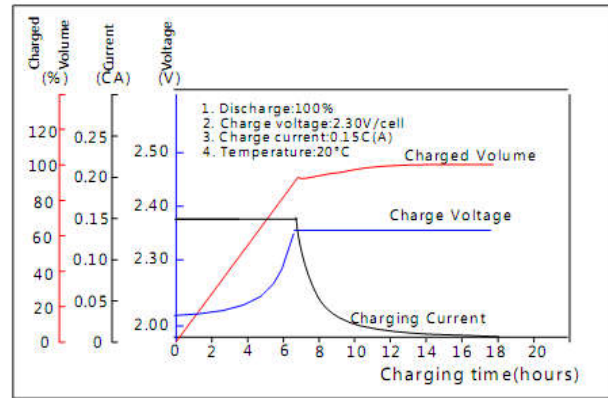

Effect of Temperature on Capacity

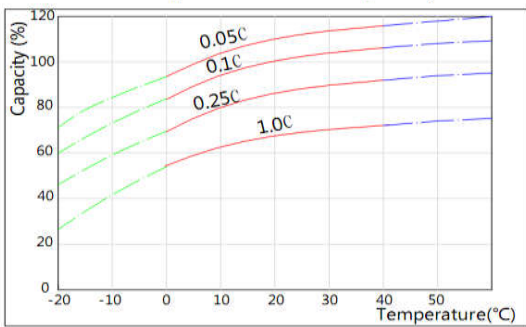

Self-discharge Characteristics

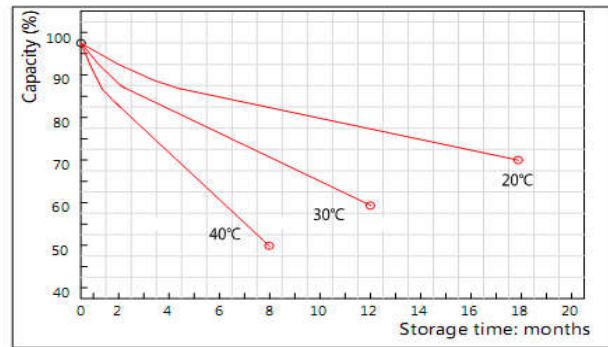

The Relationship for Open Circuit Voltage and Residual Capacity (25°C)

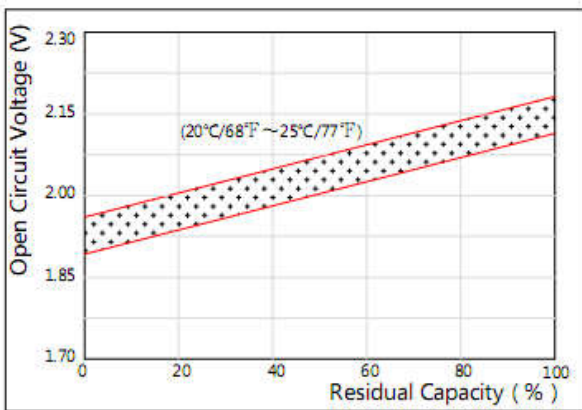

The Relationship for Charging Voltage and Temperature

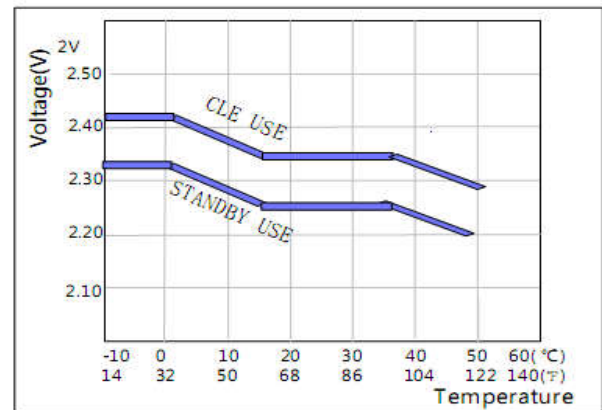

Floating Life on Temperature

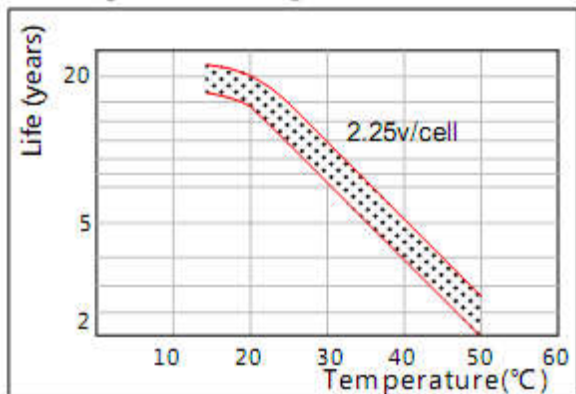

Cycle Life on D.O.D(25°C)

