

Specifications

Nominal Voltage		2 V
Capacity (25°C)	10HR(1.80V)	350 Ah
	3HR(1.75V)	267Ah
	1HR(1.75V)	198Ah
Dimension	Length	171 ± 2mm (6.73inch)
	Width	151 ± 2mm (5.94inch)
	Height	330 ± 2mm (12.99inch)
	Total Height	364 ± 2mm (14.33inch)
Approx. Weight		19.2kg (42.3bs) ± 4%
Terminal type		T10
Internal resistance (Fully charged, 25°C)		Approx. 0.65m Ω
Capacity affected by temperature (10HR)	40°C	102%
	25°C	100%
	0°C	85%
	-15°C	65%
Self-discharge (25°C)	3 month	Remaining Capacity: 91%
	6 month	Remaining Capacity: 82%
	12 month	Remaining Capacity: 65%
Nominal operating temperature		25°C ± 3°C (77°F ± 5°F)
Operating temperature range	Discharge	-15°C ~ 50°C (5°F ~ 122°F)
	Charge	-10°C ~ 50°C (14°F ~ 122°F)
	Storage	-20°C ~ 50°C (-4°F ~ 122°F)
Float charging voltage(25°C)		2.25 to 2.30V Temperature compensation: -3mV/°C
Cyclic charging voltage(25°C)		2.42 to 2.48V Temperature compensation: -5mV/°C
Maximum charging current		70A
Terminal material		Copper
Maximum discharge current		2200A(5 sec.)
Designed floating life(20°C)		20 years

- ◆ Absorbent glass mat technology;
- ◆ Recognized by UL & CE;
- ◆ ABS container.

Constant Current Discharge Characteristics (A, 25°C)

F.V/TIME	30min	60min	2h	3h	4h	5h	6h	8h	10h	20h	24h
1.60V	315	210	128	91.0	73.2	63.5	54.6	42.8	35.6	18.7	16.2
1.65V	309	207	127	90.5	72.8	63.2	54.3	42.6	35.6	18.7	16.2
1.70V	299	202	126	89.9	72.3	62.7	53.9	42.3	35.5	18.6	16.1
1.75V	292	198	124	89.3	71.8	62.3	53.6	42.0	35.2	18.5	16.0
1.80V	281	192	121	86.6	69.6	60.4	51.9	40.7	35.0	18.4	15.9

Constant Power Discharge Characteristics (Watt, 25°C)

F.V/TIME	30min	60min	2h	3h	4h	5h	6h	8h	10h	20h	24h
1.60V	589	399	247	178	143	125	108	85.3	70.9	37.4	32.6
1.65V	577	393	245	177	143	124	107	84.8	70.8	37.3	32.5
1.70V	560	383	243	176	142	124	106	84.2	70.6	37.2	32.4
1.75V	546	375	240	175	141	123	105	83.6	70.1	37.0	32.2
1.80V	526	364	233	170	136	119	102	81.1	69.7	36.8	32.0

Note: The above characteristics data can be obtained within three charge/discharge cycles.



Dimensions

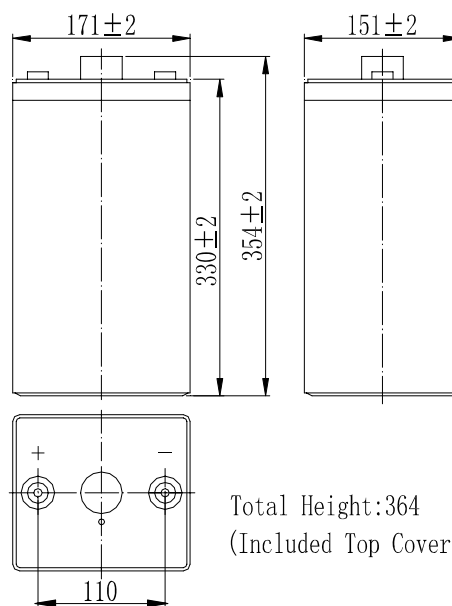

Total Height: 364
(Included Top Cover)

Terminal

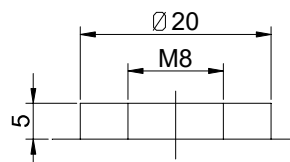

Terminal T10

Discharge Characteristics(25°C)

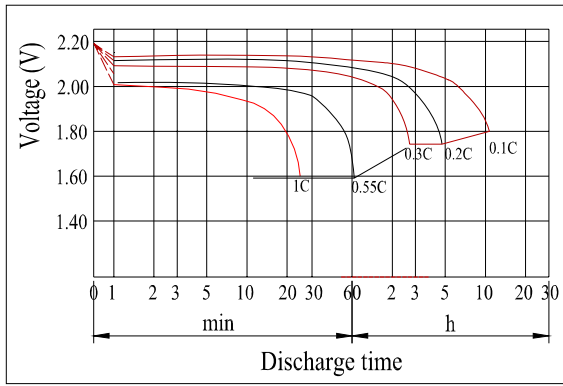

Charging Characteristics(25°C)

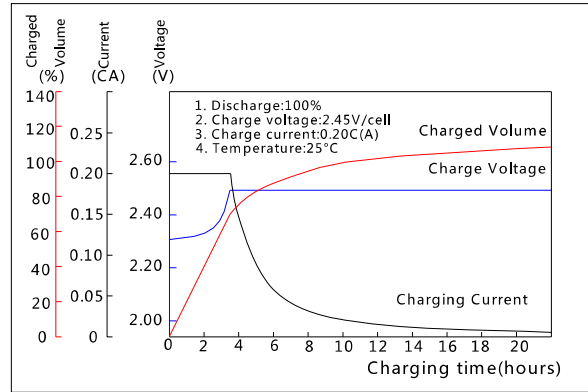

Effect of Temperature on Capacity

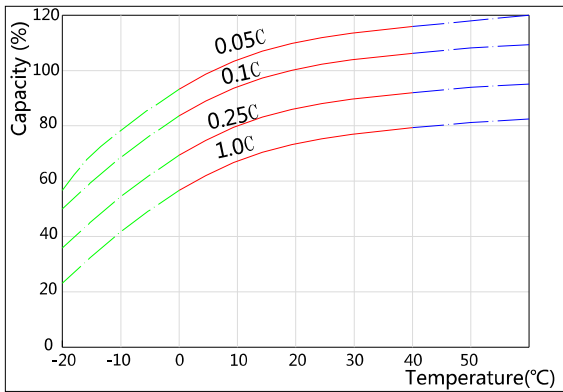

Self-discharge Characteristics

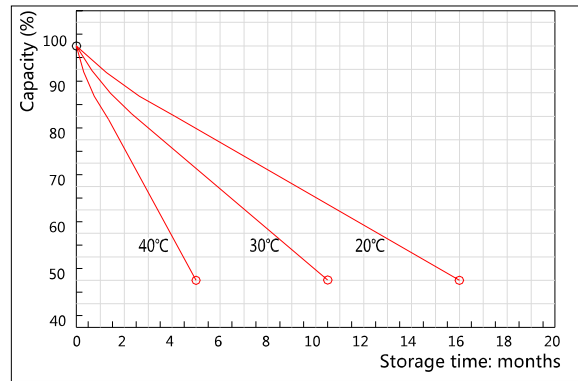

The Relationship for Open Circuit Voltage and Residual Capacity (25°C)

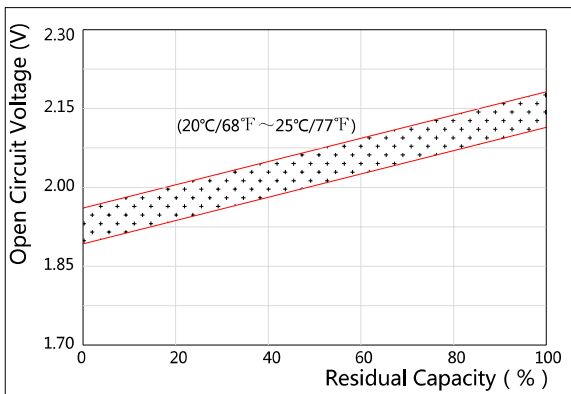

The Relationship for Charging Voltage and Temperature

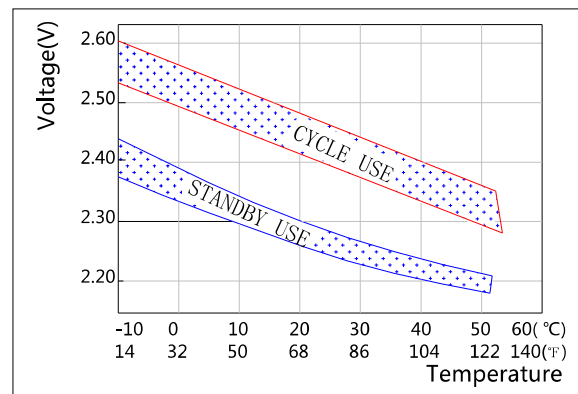

Floating Life on Temperature

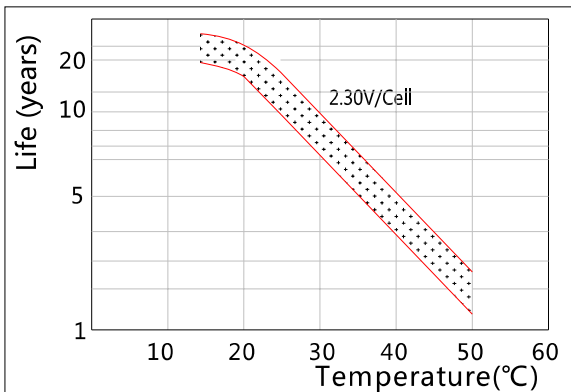

Cycle Life on D.O.D(25°C)

