

**Specifications**

Nominal Voltage		2 V
Capacity (25°C)	10HR(1.80V)	300 Ah
	3HR(1.75V)	229.5Ah
	1HR(1.75V)	169Ah
Dimension	Length	171 ± 2mm (6.73inch)
	Width	151 ± 2mm (5.94inch)
	Height	330 ± 2mm (12.99inch)
	Total Height	364 ± 2mm (14.33inch)
Approx. Weight		17.5kg (38.6lbs) ± 4%
Terminal type		T10
Internal resistance (Fully charged, 25°C)		Approx. 0.75m Ω
Capacity affected by temperature (10HR)	40°C	102%
	25°C	100%
	0°C	85%
	-15°C	65%
Self-discharge (25°C)	3 month	Remaining Capacity: 91%
	6 month	Remaining Capacity: 82%
	12 month	Remaining Capacity: 65%
Nominal operating temperature		25°C ± 3°C (77°F ± 5°F)
Operating temperature range	Discharge	-15°C ~ 50°C (5°F ~ 122°F)
	Charge	-10°C ~ 50°C (14°F ~ 122°F)
	Storage	-20°C ~ 50°C (-4°F ~ 122°F)
Float charging voltage(25°C)		2.25 to 2.30V Temperature compensation: -3mV/°C
Cyclic charging voltage(25°C)		2.42 to 2.48V Temperature compensation: -5mV/°C
Maximum charging current		60A
Terminal material		Copper
Maximum discharge current		2000A(5 sec.)
Designed floating life(20°C)		20 years

- ◆ Absorbent glass mat technology;
- ◆ Recognized by UL & CE;
- ◆ ABS container.

**Constant Current Discharge Characteristics (A, 25°C)**

F.V/TIME	30min	60min	2h	3h	4h	5h	6h	8h	10h	20h	24h
1.60V	270	180	110	78.0	62.7	54.5	46.8	36.7	30.5	16.0	13.9
1.65V	265	177	109	77.6	62.4	54.1	46.5	36.5	30.5	16.0	13.9
1.70V	257	173	108	77.0	61.9	53.8	46.2	36.3	30.4	16.0	13.8
1.75V	250	169	106	76.5	61.5	53.4	45.9	36.0	30.2	15.9	13.7
1.80V	241	164	104	74.2	59.7	51.8	44.5	34.9	30.0	15.8	13.7

**Constant Power Discharge Characteristics (Watt, 25°C)**

F.V/TIME	30min	60min	2h	3h	4h	5h	6h	8h	10h	20h	24h
1.60V	505	342	212	153	123	107	92.2	73.1	60.8	32.1	27.9
1.65V	495	337	210	152	122	107	91.7	72.6	60.7	32.0	27.9
1.70V	480	328	208	151	121	106	91.1	72.1	60.5	31.9	27.8
1.75V	468	322	205	150	121	105	90.4	71.6	60.1	31.7	27.6
1.80V	451	312	200	145	117	102	87.7	69.5	59.7	31.5	27.4

Note: The above characteristics data can be obtained within three charge/discharge cycles.



**Dimensions**

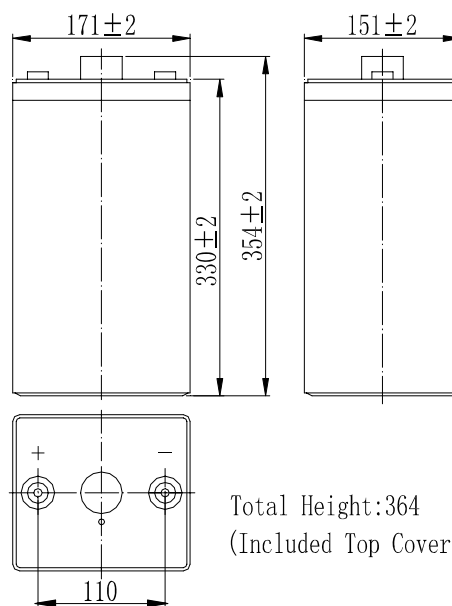

Total Height: 364  
(Included Top Cover)

**Terminal**

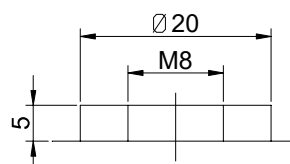

Terminal T10

Discharge Characteristics(25°C)

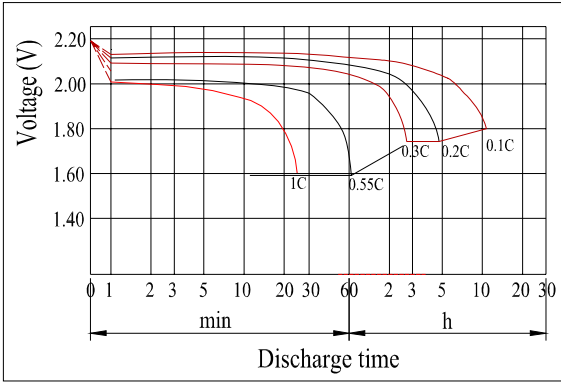

Charging Characteristics(25°C)

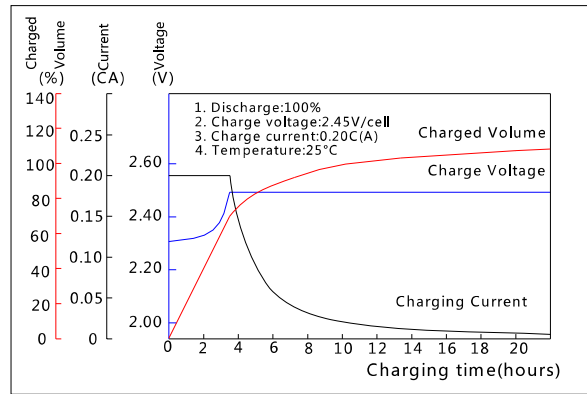

Effect of Temperature on Capacity

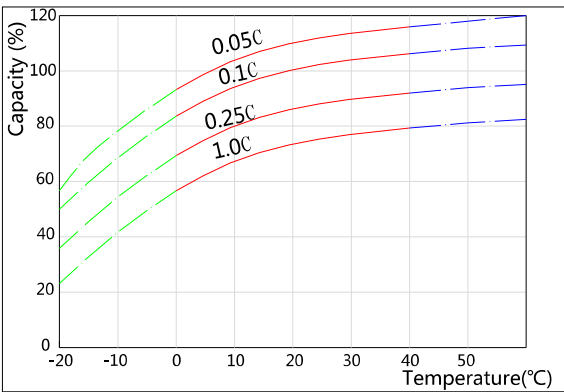

Self-discharge Characteristics

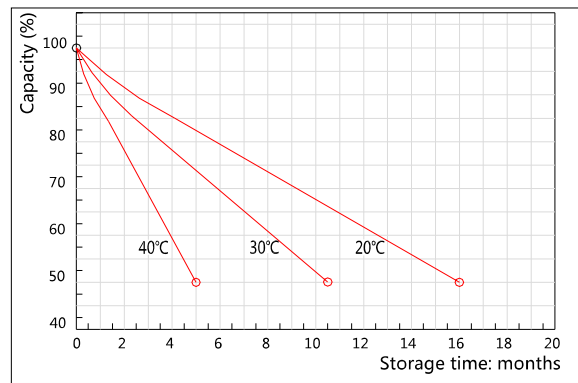

The Relationship for Open Circuit Voltage and Residual Capacity (25°C)

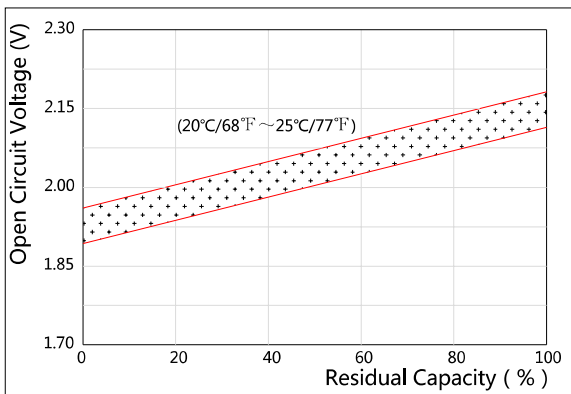

The Relationship for Charging Voltage and Temperature

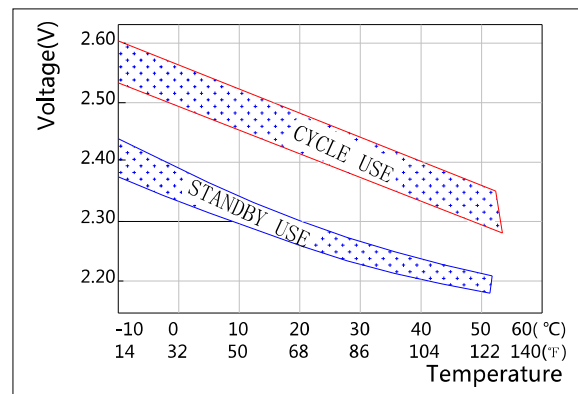

Floating Life on Temperature

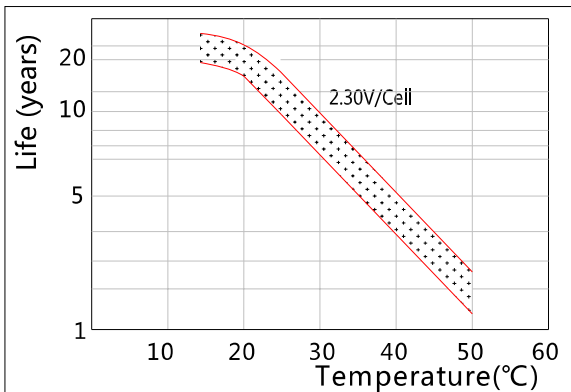

Cycle Life on D.O.D(25°C)

